

Features

- Input Voltage Range: 2.5 V to 20 V
- Output Voltage Range:
 - Adjustable: 1.22 V to 18 V
 - Fixed: 1.5 V to 5 V
- $\pm 2\%$ Output Accuracy over Line Regulation, Load Regulation, and Operating Temperature Range
- 300-mA Maximum Output Current
- Low Dropout Voltage: 550 mV Maximum at 300 mA
- High PSRR:
 - 79 dB at 1 kHz
 - 56 dB at 100 kHz
- 5.68- μV_{RMS} Output Voltage Noise
- Excellent Transient Response
- Stable with a 2.2- μF to 100- μF Ceramic Output Capacitor
- Integrated Protection:
 - Over-Current Protection
 - Output Short-Circuit Protection
 - Over-Temperature Protection
- Junction Temperature Range: -40°C to $+125^{\circ}\text{C}$
- Package Options:
 - SOT23-5

Applications

- Low-Noise Power Supply
- High-Definition Imaging System
- Infrared Image Equipment
- Medical Equipment

Description

The TPL8032 series of products are 300-mA high PSRR, ultra-low noise, and low-dropout linear regulators with a 20-V wide input voltage range. The TPL8032 series of products support both adjustable output voltage ranging from 1.22 V to 18 V with an external resistor divider and fixed output voltage ranging from 1.5 V to 5 V. The TPL8032 series of products are stable with a 2.2- μF to 100- μF ceramic output capacitor.

The TPL8032 series of products have high PSRR with 79 dB at 1 kHz and 5.68 μV_{RMS} ultra-low noise. These features make the TPL8032 series suitable for noise-sensitive applications, such as high-performance analog devices or high-definition imaging equipment, to suppress the large ripple and noise generated from the previous stage power supply. Besides, output short-circuit protection and thermal protection features improve the system reliability under multiple operating conditions.

The TPL8032 series provides the SOT23-5 package with a guaranteed junction temperature range from -40°C to $+125^{\circ}\text{C}$.

Typical Application Circuit

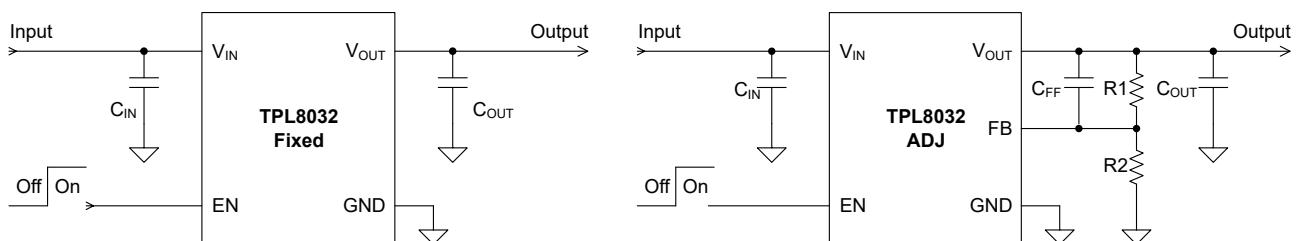

Table of Contents

Features	1
Applications	1
Description	1
Typical Application Circuit	1
Product Family Table	3
Revision History	3
Pin Configuration and Functions	4
Specifications	5
Absolute Maximum Ratings	5
ESD, Electrostatic Discharge Protection.....	5
Recommended Operating Conditions.....	5
Thermal Information.....	5
Electrical Characteristics.....	6
Typical Performance Characteristics.....	8
Detailed Description	11
Overview.....	11
Functional Block Diagram.....	11
Feature Description.....	11
Application and Implementation	13
Application Information	13
Typical Application.....	13
Layout	15
Layout Guideline.....	15
Tape and Reel Information	16
Package Outline Dimensions	17
SOT23-5.....	17
Order Information	18
IMPORTANT NOTICE AND DISCLAIMER	19

Product Family Table

Orderable Part Number	Output Voltage	Package
TPL8032AD-S5TR	Adjustable	SOT23-5
TPL803233-S5TR	Fixed 3.3 V	SOT23-5
TPL803250-S5TR	Fixed 5.0 V	SOT23-5

Revision History

Date	Revision	Notes
2020-12-31	Rev.Pre.0	Preliminary Version.
2023-01-15	Rev.A.0	Initial Released.
2023-04-15	Rev.A.1	1. Added Minimum and Maximum Value of I_{FB} . 2. Added Dropout Voltage of Adjustable Output Option.
2024-03-30	Rev.A.2	Updated Thermal information

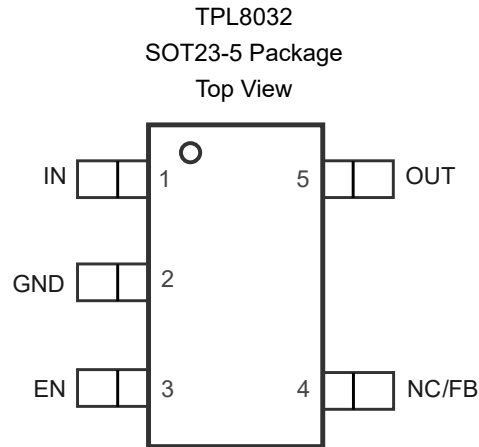
Pin Configuration and Functions

Table 1. Pin Functions: TPL8032

Pin No.	Pin Name	I/O	Description
3	EN	I	Regulator enable pin. Drive EN high to turn on the regulator; and drive EN low to turn off the regulator.
4	FB	I	Output voltage feedback pin (adjustable output only). Connect to a resistor divider to adjust the output voltage.
2	GND	–	Ground reference pin. Connect the GND pin to the PCB ground plane directly.
1	IN	I	Input voltage pin. Bypass IN to GND with a 10- μ F or greater capacitor.
4	NC	–	No connection (fixed output only).
5	OUT	O	Regulated output voltage pin.

20-V/300-mA Wide-Input High-PSRR Ultra-Low Noise LDO Regulator

Specifications

Absolute Maximum Ratings

Parameter		Min	Max	Unit
V_{IN}, V_{EN}		-0.3	24	V
V_{OUT} (fixed output only)		-0.3	6	V
V_{OUT} (adjustable output only)		-0.3	24	V
V_{FB} (adjustable output only)		-0.3	6	V
T_J	Maximum Junction Temperature	-40	150	°C
T_{STG}	Storage Temperature Range	-65	150	°C
T_L	Lead Temperature (Soldering 10 sec)		260	°C

- (1) Stresses beyond those listed under Absolute Maximum Ratings may cause permanent damage to the device. Exposure to any Absolute Maximum Rating condition for extended periods may affect device reliability and lifetime.
 (2) All voltage values are with respect to GND.

ESD, Electrostatic Discharge Protection

Parameter		Condition	Minimum Level	Unit
HBM	Human Body Model ESD	ANSI/ESDA/JEDEC JS-001 ⁽¹⁾	±2	kV
CDM	Charged Device Model ESD	ANSI/ESDA/JEDEC JS-002 ⁽²⁾	±1.5	kV

- (1) JEDEC document JEP155 states that 500-V HBM allows safe manufacturing with a standard ESD control process.
 (2) JEDEC document JEP157 states that 250-V CDM allows safe manufacturing with a standard ESD control process.

Recommended Operating Conditions

Parameter		Min	Max	Unit
V_{IN}		2.5	20	V
V_{EN}		0	V_{IN}	V
C_{OUT}		2.2	100	μF
T_J	Junction Temperature Range	-40	125	°C

Thermal Information

Package Type	θ_{JA}	θ_{JB}	$\theta_{JC, TOP}$	Unit
SOT23-5	162.4	79	62.33	°C/W

20-V/300-mA Wide-Input High-PSRR Ultra-Low Noise LDO Regulator

Electrical Characteristics

All test conditions: $-40^{\circ}\text{C} \leq T_J \leq 125^{\circ}\text{C}$, $V_{\text{IN}} = V_{\text{OUT(NOM)}} + 1\text{ V}$ or 2.5 V , whichever is greater; typically, $T_J = 25^{\circ}\text{C}$, $V_{\text{OUT}} = 3.3\text{ V}$, $C_{\text{IN}} = C_{\text{OUT}} = 4.7\text{ }\mu\text{F}$, and $C_{\text{FF}} = 100\text{ nF}$ for adjustable output, unless otherwise noted.

Parameter	Conditions	Min	Typ	Max	Unit
Supply Input Voltage and Current					
V_{IN}	Input Supply Voltage Range ⁽¹⁾	$V_{\text{IN(MIN)}}$		20	V
UVLO	Input Supply Voltage Rising		2.25	2.4	V
	Hysteresis		200		mV
I_{Q}	Quiescent Current	$I_{\text{OUT}} = 0\text{ mA}$	98	160	μA
		$I_{\text{OUT}} = 1\text{ mA}$	127		μA
I_{SD}	Shutdown Current	$\text{EN} = \text{GND}$, $V_{\text{IN}} = V_{\text{IN(MIN)}}$ to 20 V	0.6	5	μA
Enable Input Voltage and Current					
$V_{\text{IH(EN)}}$	EN Input High Level (enable)	1.6		V_{IN}	V
$V_{\text{IL(EN)}}$	EN Input Low Level (disable)	0		0.5	V
I_{EN}	EN Pin Leakage Current	$V_{\text{EN}} = 0\text{ V}$ to 20 V	0.5	1	μA
Regulated Output Voltage and Current					
V_{OUT}	Output Voltage Accuracy ⁽²⁾	-2%		2%	
V_{FB}	Feedback Pin Voltage ⁽²⁾	Adjustable output only	1.22		V
I_{FB}	Feedback Pin Leakage Current ⁽²⁾	$V_{\text{FB}} = 1.5\text{ V}$	-100	100	nA
ΔV_{OUT}	Line Regulation	$V_{\text{IN}} = V_{\text{OUT(NOM)}} + 1\text{ V}$ to 20 V , $I_{\text{OUT}} = 1\text{ mA}$	0.007		%/V
	Load Regulation	$I_{\text{OUT}} = 1\text{ mA}$ to 300 mA	0.01		%/mA
V_{DO}	Dropout Voltage ⁽³⁾ of Fixed Output Option	$I_{\text{OUT}} = 100\text{ mA}$, $V_{\text{OUT}} = 5\text{ V}$	210	250	mV
		$I_{\text{OUT}} = 300\text{ mA}$, $V_{\text{OUT}} = 5\text{ V}$	350	550	mV
		$I_{\text{OUT}} = 100\text{ mA}$, $V_{\text{OUT}} = 3.3\text{ V}$	210	250	mV
		$I_{\text{OUT}} = 300\text{ mA}$, $V_{\text{OUT}} = 3.3\text{ V}$	350	550	mV
	Dropout Voltage ⁽³⁾ of Adjustable Output Option	$I_{\text{OUT}} = 100\text{ mA}$, $V_{\text{OUT}} = 18\text{ V}$	125	200	mV
		$I_{\text{OUT}} = 300\text{ mA}$, $V_{\text{OUT}} = 18\text{ V}$	375	600	mV
		$I_{\text{OUT}} = 100\text{ mA}$, $V_{\text{OUT}} = 10\text{ V}$	125	200	mV
		$I_{\text{OUT}} = 300\text{ mA}$, $V_{\text{OUT}} = 10\text{ V}$	375	600	mV
I_{LIM}	Output Current Limit	$V_{\text{OUT}} = 0.9 \times V_{\text{OUT(NOM)}}$	310	450	mA
I_{SC}	Short-Circuit Current Limit	V_{OUT} is forced to $\leq 20\text{ mV}$	180		mA
PSRR	Power Supply Rejection Ratio ⁽⁴⁾	$I_{\text{OUT}} = 100\text{ mA}$, $f = 120\text{ Hz}$	79		dB
		$I_{\text{OUT}} = 100\text{ mA}$, $f = 1\text{ kHz}$	79		dB
		$I_{\text{OUT}} = 100\text{ mA}$, $f = 100\text{ kHz}$	56		dB
		$I_{\text{OUT}} = 100\text{ mA}$, $f = 1\text{ MHz}$	41		dB
V_{N}	Output Noise Voltage ⁽⁴⁾	$I_{\text{OUT}} = 100\text{ mA}$, $\text{BW} = 10\text{ Hz}$ to 100 kHz	5.68		μV_{RMS}

**20-V/300-mA Wide-Input High-PSRR Ultra-Low Noise LDO
Regulator**

Parameter		Conditions	Min	Typ	Max	Unit
t _{STR}	Start-up Time (4)	From EN ≥ V _{IH(EN)} to OUT ≥ 95% of V _{OUT(NOM)}		600		μs
Operating Temperature Range						
T _{SD}	Thermal Shutdown Temperature			165		°C
	Hysteresis			25		°C

(1) V_{IN(MIN)} = V_{OUT(NOM)} + 1 V or 2.5 V, whichever is greater.

(2) FB pin is available for adjustable output only. Tolerance of external resistors is not included.

(3) Dropout voltage is the minimum input to output voltage differential needed to maintain regulation at a specified output current and measure for V_{OUT(NOM)} ≥ 2.5V. In the dropout mode, the output voltage will be equal to V_{IN} - V_{DO}.

(4) Not test during production. Measured with C_{OUT} = 2.2 μF.

Typical Performance Characteristics

All test conditions: $-40^{\circ}\text{C} \leq T_J \leq 125^{\circ}\text{C}$, $V_{IN} = V_{OUT(NOM)} + 1\text{ V}$ or 2.5 V , whichever is greater; typically, $T_J = 25^{\circ}\text{C}$, $V_{OUT} = 3.3\text{ V}$, $C_{IN} = 4.7\text{ }\mu\text{F}$, $C_{OUT} = 2.2\text{ }\mu\text{F}$, and $C_{FF} = 100\text{ nF}$ for adjustable output, unless otherwise noted.

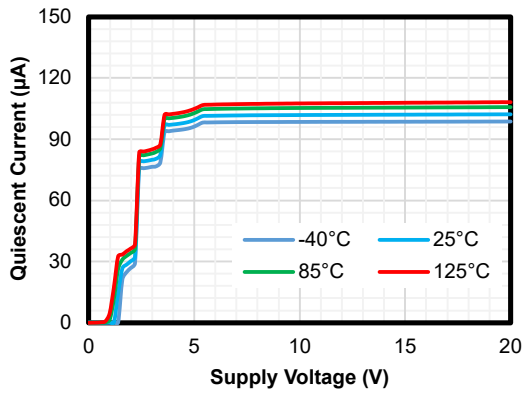

Figure 1. Quiescent Current vs Supply Voltage

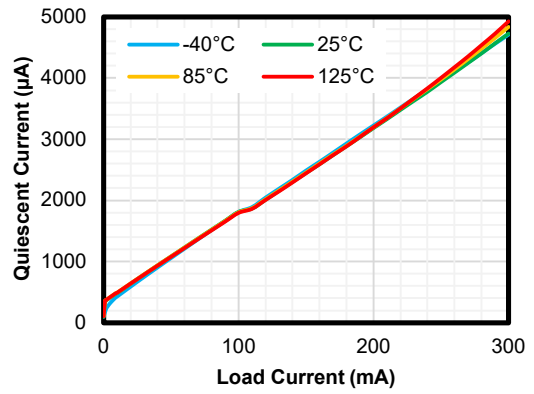

Figure 2. Quiescent Current vs Load Current

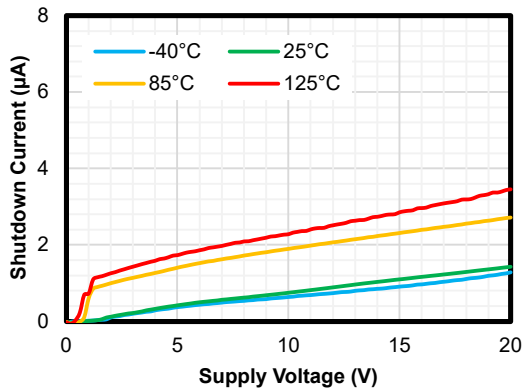

Figure 3. Shutdown Current vs Supply Voltage

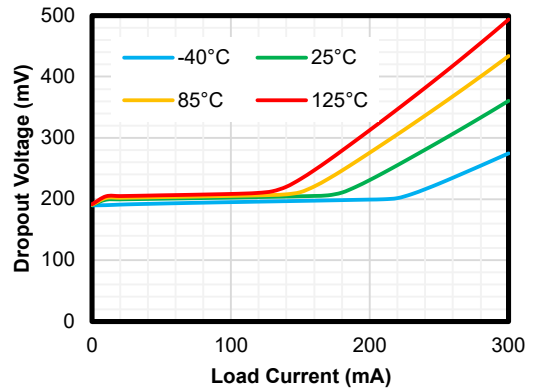

Figure 4. Dropout Voltage vs Load Current

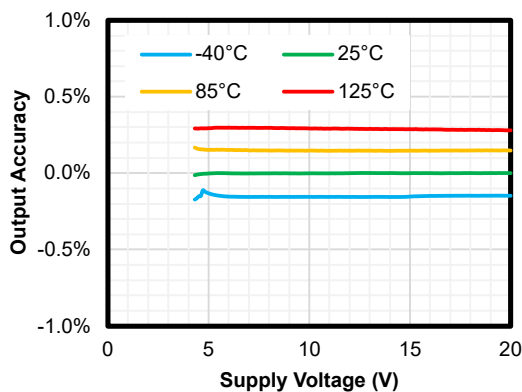

Figure 5. Line Regulation

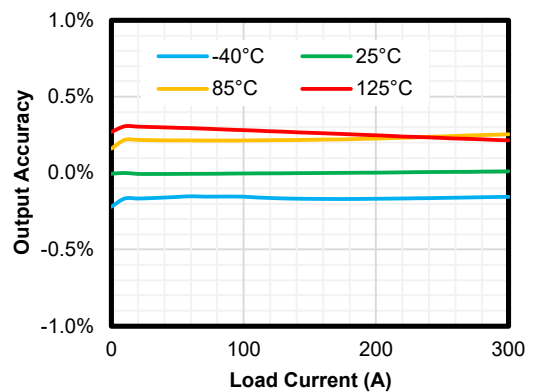

Figure 6. Load Regulation

20-V/300-mA Wide-Input High-PSRR Ultra-Low Noise LDO Regulator

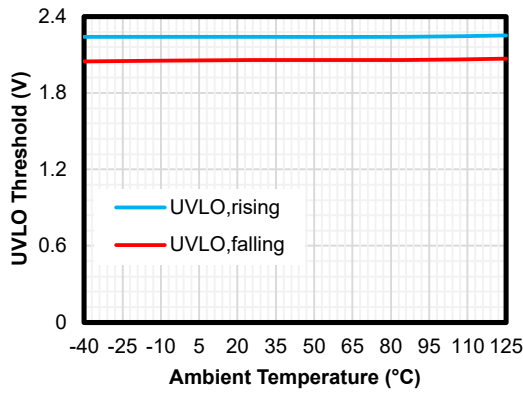

Figure 7. UVLO vs Temperature

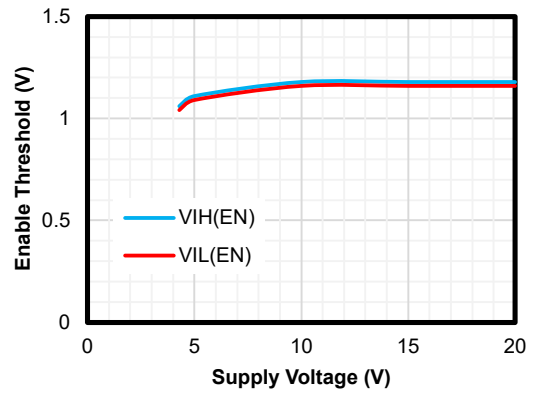

Figure 8. EN threshold vs Supply Voltage

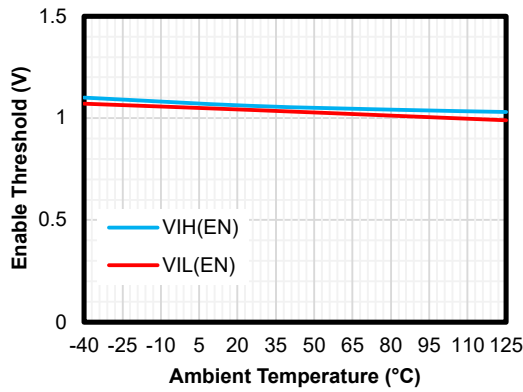

Figure 9. EN Threshold vs Temperature

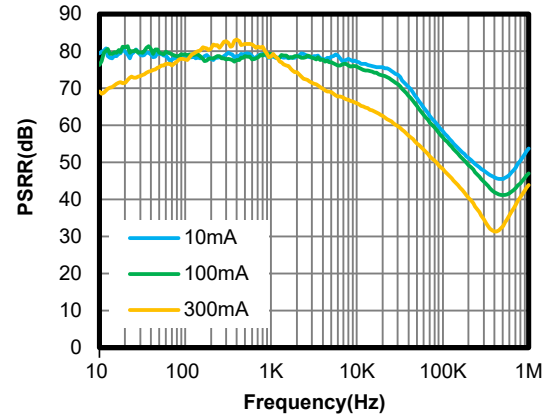

Figure 10. PSRR

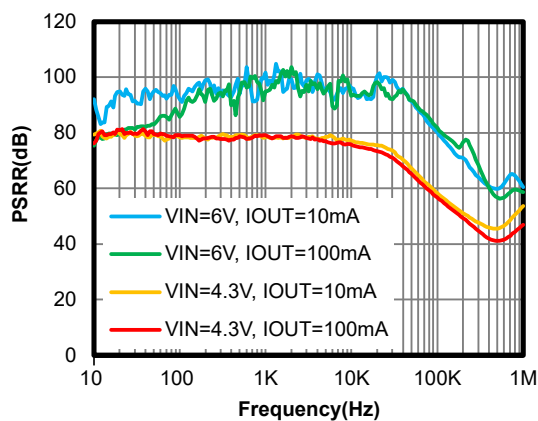

Figure 11. PSRR

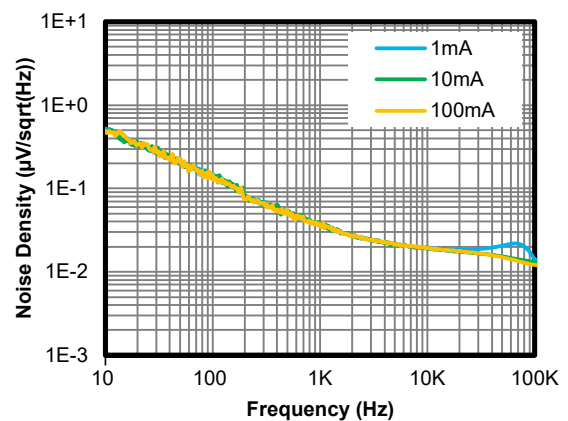

Figure 12. Noise

20-V/300-mA Wide-Input High-PSRR Ultra-Low Noise LDO Regulator

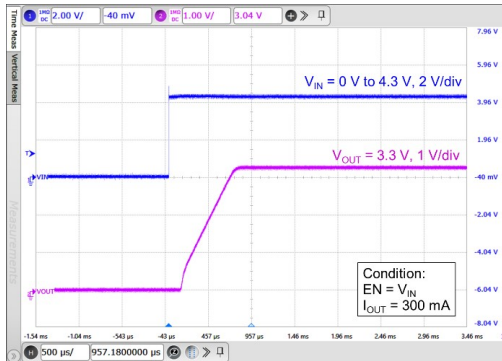

Figure 13. Startup with V_{IN}

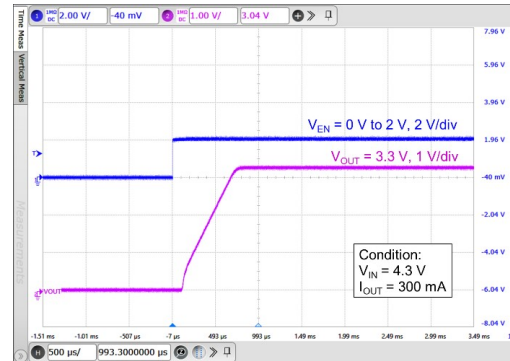

Figure 14. Startup with EN

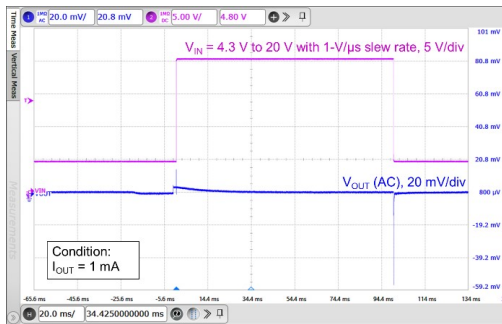

Figure 15. Line Transient

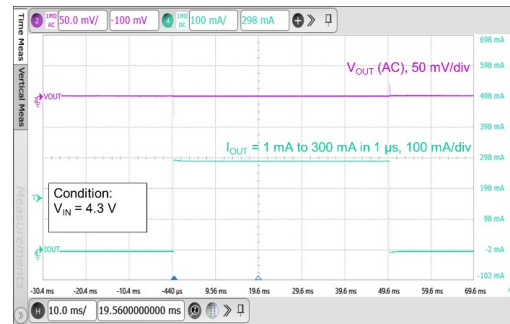

Figure 16. Load Transient

Detailed Description

Overview

The TPL8032 series of products are 300-mA high PSRR, ultra-low noise, and low-dropout linear regulators with a 20-V wide input voltage range. The TPL8032 series of products support both adjustable output voltage ranging from 1.22 V to 18 V with an external resistor divider and fixed output voltage ranging from 1.5 V to 5 V. The TPL8032 series of products are stable with a 2.2- μ F to 100- μ F ceramic output capacitor.

The TPL8032 series of products have high PSRR with 79 dB at 1 kHz and 5.68 μ V_{RMS} ultra-low noise. These features make the TPL8032 series suitable for noise-sensitive applications, such as high-performance analog devices or high-definition imaging equipment, to suppress the large ripple and noise generated from the previous stage power supply. Besides, output short-circuit protection and thermal protection features improve system reliability under multiple operating conditions.

Functional Block Diagram

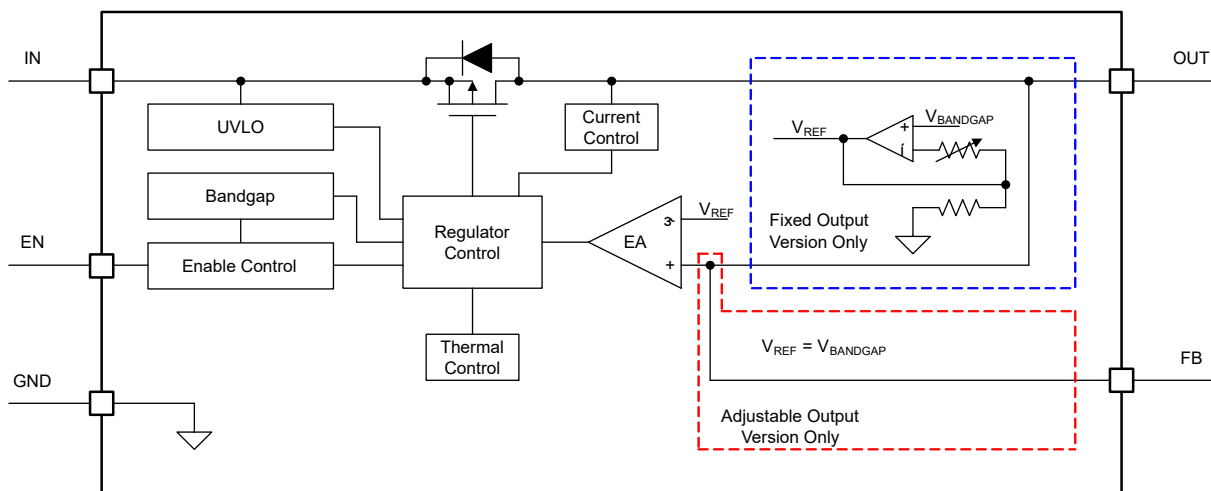

Figure 17. Functional Block Diagram

Feature Description

Enable (EN)

The enable pin (EN) is active high. Connect this pin to the GPIO of an external processor or digital logic control circuit to enable and disable the device. Or connect this pin to the IN pin for self-bias applications.

Under-Voltage Lockout (UVLO)

The TPL8032 series uses an under-voltage lockout circuit to keep the output shut off until the internal circuitry operates properly. Refer to the [Electrical Characteristics](#) table for the UVLO threshold and hysteresis.

Fixed Output Voltage

The TPL8032 series is available in fixed voltage versions of 1.5 V to 5 V. When the input voltage is higher than $V_{OUT(NOM)} + 1$ V, the output voltage is well regulated according to the selected voltage option. When the input voltage falls below $V_{OUT(NOM)} + 1$ V, the output voltage tracks the input voltage minus the dropout voltage according to the load current. When the input voltage falls below UVLO, the output turns off.

Adjustable Output Voltage (FB and OUT)

The output voltage of the TPL8032 series with the FB pin can be set from 1.22 V to 18 V by selecting different external resistors. Use [Equation 1](#) to calculate the output voltage.

$$V_{OUT} = V_{FB} \times \left(1 + \frac{R1}{R2}\right) \quad (1)$$

Where the feedback voltage V_{FB} is 1.22 V.

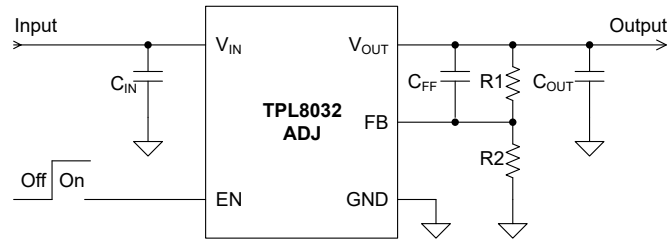

Figure 18. Adjustable Output

Over-Current Protection and Short-to-Ground Protection

The TPL8032 series integrates an internal current limit that helps to protect the regulator during fault conditions.

- When the output voltage is pulled down below the regulated voltage, over-current protection starts to work and limits the output current to I_{LIM} .
- When the output voltage is pulled down below 20 mV, or shorted to the ground directly, short-to-ground protection starts to work and limits the output current to I_{SC} .
- During startup, the output current is limited to I_{SC} before the output voltage ramps higher than the short-to-ground threshold.

Under the over-current conditions, the internal junction temperature ramps up quickly. When the junction temperature is high enough, it will cause over-temperature protection.

Over-Temperature Protection

The over-temperature protection starts to work when the junction temperature exceeds the thermal shutdown threshold, which turns off the regulator immediately. Until when the device cools down and the junction temperature falls below the thermal shutdown threshold minus thermal shutdown hysteresis, the regulator turns on again.

The junction temperature range should be limited according to the [Recommended Operating Conditions](#) table, continuously operating above the junction temperature range will reduce the device lifetime.

Application and Implementation

Note

Information in the following application sections is not part of the 3PEAK's component specification and 3PEAK does not warrant its accuracy or completeness. 3PEAK's customers are responsible for determining suitability of components for their purposes. Customers should validate and test their design implementation to confirm system functionality.

Application Information

The TPL8032 devices are a series of 20-V, 300-mA high PSRR, ultra-low noise, low-dropout linear regulators. The following application schematics show the typical usage of the TPL8032 series.

Typical Application

Figure 19 and Figure 20 show the typical application schematics of the TPL8032 series.

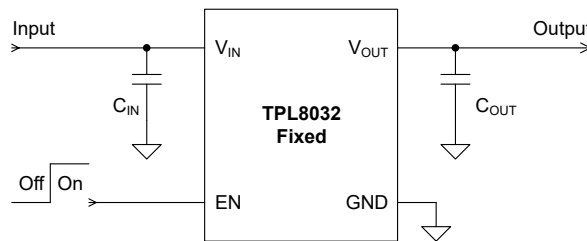

Figure 19. Typical Application Schematic of Fixed Output

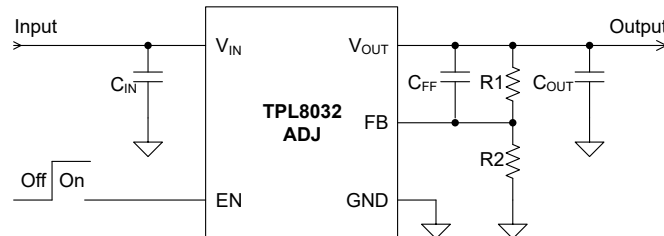

Figure 20. Typical Application Schematic of Adjustable Output

Input Capacitor and Output Capacitor

3PEAK recommends adding a 4.7- μF or greater capacitor with a 0.1- μF bypass capacitor in parallel at the IN pin to keep the input voltage stable. The voltage rating of the capacitors must be greater than the maximum input voltage.

To ensure loop stability, the TPL8032 series requires an output capacitor of 2.2 μF to 100 μF . 3PEAK recommends selecting an X7R type 4.7- μF ceramic capacitor with the low ESR over temperature.

Both input capacitors and output capacitors must be placed as close to the device pins as possible.

Power Dissipation

During normal operation, LDO junction temperature should meet the requirement in the [Recommended Operating Conditions](#) table. Using the below equations to calculate the power dissipation and estimate the junction temperature.

The power dissipation can be calculated using [Equation 2](#).

**20-V/300-mA Wide-Input High-PSRR Ultra-Low Noise LDO
Regulator**

$$P_D = (V_{IN} - V_{OUT}) \times I_{OUT} + V_{IN} \times I_{GND} \quad (2)$$

The junction temperature can be estimated using [Equation 3](#). θ_{JA} is the junction-to-ambient thermal resistance.

$$T_J = T_A + P_D \times \theta_{JA} \quad (3)$$

Layout

Layout Guideline

- Both input capacitors and output capacitors must be placed to the device pins as close as possible, and the vias between capacitors and device power pins must be avoided.
- It is recommended to bypass the input pin to ground with a 0.1- μ F bypass capacitor. The loop area formed by the bypass capacitor connection, the IN pin and the GND pin of the system must be as small as possible.
- It is recommended to use wide and thick copper to minimize I \times R drop and heat dissipation.

Tape and Reel Information

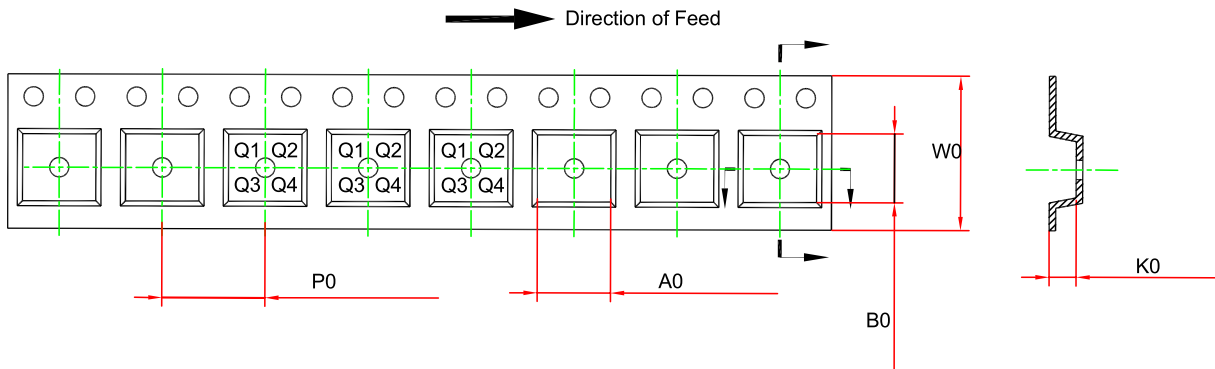
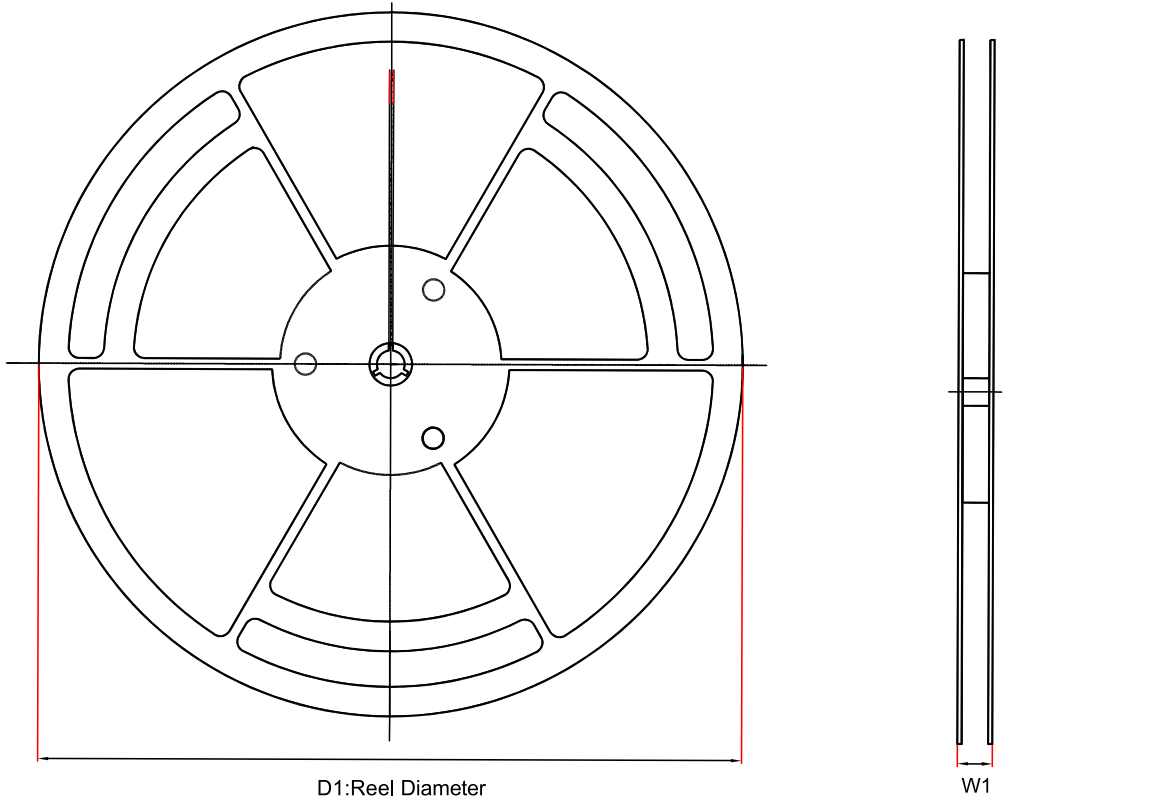

Order Number	Package	D1 (mm)	W1 (mm)	A0 (mm)	B0 (mm)	K0 (mm)	P0 (mm)	W0 (mm)	Pin1 Quadrant
TPL8032xx-S5TR	SOT23-5	180	12	3.3	3.25	1.4	4	8	Q3

(1) Output voltage value, xx = 15 to 50 and AD, e.g., 33 means 3.3 V output voltage, and AD means adjustable output.

Package Outline Dimensions

SOT23-5

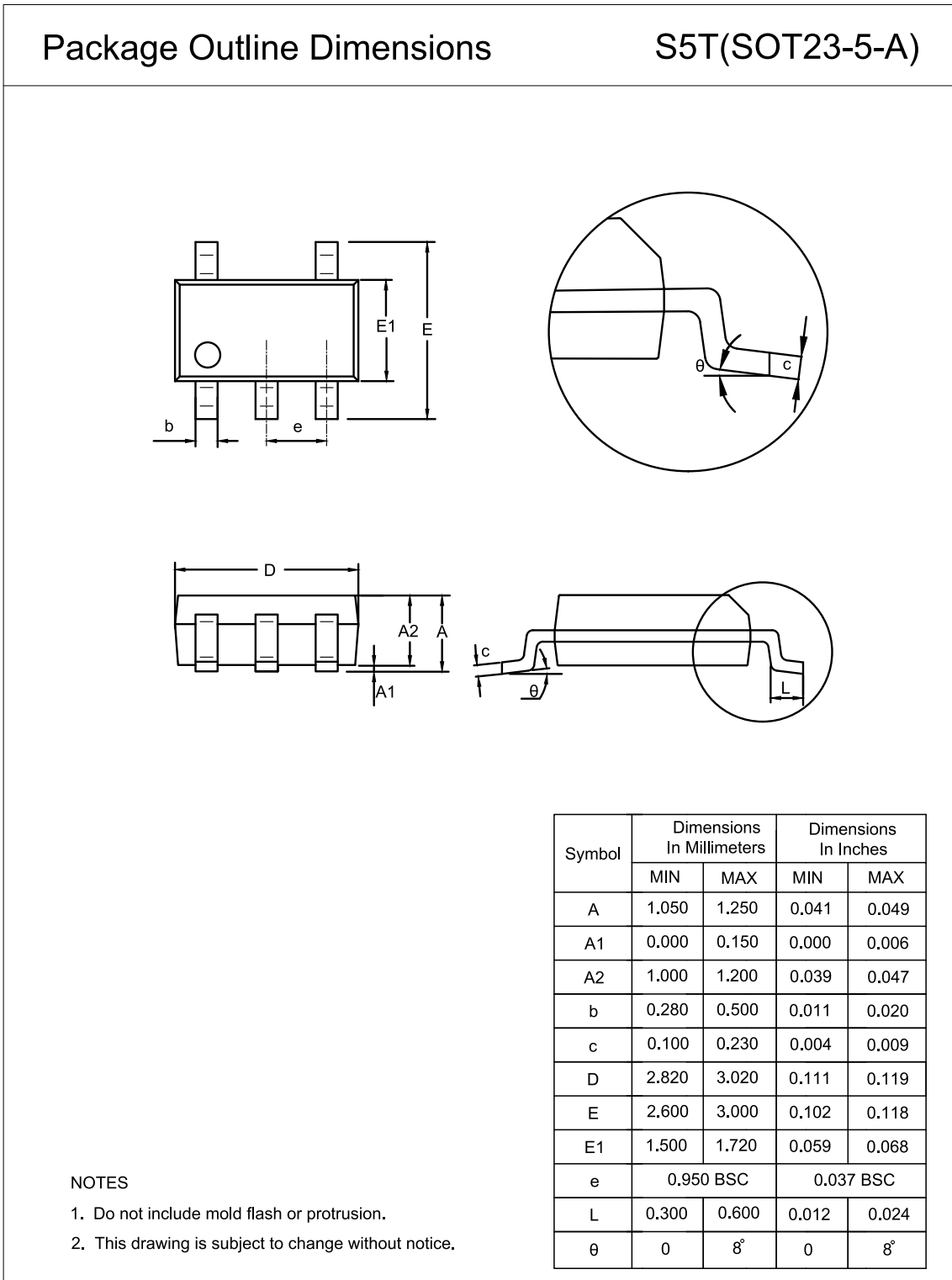

Order Information

Order Number	Operating Temperature Range	Package	Marking Information	MSL	Transport Media, Quantity	Eco Plan
TPL8032AD-S5TR ⁽¹⁾	-40 to 125°C	SOT23-5	LBA	MSL3	Tape and Reel, 3,000	Green
TPL803233-S5TR	-40 to 125°C	SOT23-5	LBJ	MSL3	Tape and Reel, 3,000	Green
TPL803250-S5TR	-40 to 125°C	SOT23-5	LBR	MSL3	Tape and Reel, 3,000	Green

(1) For future products, contact the 3PEAK factory for more information and samples.

Green: 3PEAK defines "Green" to mean RoHS compatible and free of halogen substances.

IMPORTANT NOTICE AND DISCLAIMER

Copyright© 3PEAK 2012-2024. All rights reserved.

Trademarks. Any of the 思瑞浦 or 3PEAK trade names, trademarks, graphic marks, and domain names contained in this document /material are the property of 3PEAK. You may NOT reproduce, modify, publish, transmit or distribute any Trademark without the prior written consent of 3PEAK.

Performance Information. Performance tests or performance range contained in this document/material are either results of design simulation or actual tests conducted under designated testing environment. Any variation in testing environment or simulation environment, including but not limited to testing method, testing process or testing temperature, may affect actual performance of the product.

Disclaimer. 3PEAK provides technical and reliability data (including data sheets), design resources (including reference designs), application or other design recommendations, networking tools, security information and other resources "As Is". 3PEAK makes no warranty as to the absence of defects, and makes no warranties of any kind, express or implied, including without limitation, implied warranties as to merchantability, fitness for a particular purpose or non-infringement of any third-party's intellectual property rights. Unless otherwise specified in writing, products supplied by 3PEAK are not designed to be used in any life-threatening scenarios, including critical medical applications, automotive safety-critical systems, aviation, aerospace, or any situations where failure could result in bodily harm, loss of life, or significant property damage. 3PEAK disclaims all liability for any such unauthorized use.

This page intentionally left blank