



Ultra-low Power, 1-Channel 6th-Order SD Video Filter Driver

Features

- Single SDTV Filter
- 6th-order Butterworth Low-Pass Filter:
 - 9MHz -3dB Bandwidth, 57.2dB Attenuation(27MHz)
- Support Multiple Input Biasing:
 - Provide 80-mV Level-Shift when DC-Coupled
 - Transparent Input Clamping when AC-Coupled
 - Support External DC Biasing when AC-Coupled
- Very Low Quiescent Current: 3.85mA (Typical)
- Slew Rate: 38V/μs
- 6dB Gain (2V/V) with Rail-to-Rail Output
- AC- or DC-Coupled Output Driving Dual Video Loads (75Ω)
- Wide Operation Range: +2.85V to +5.5V Single Supply
- Robust ESD Protection:
 - HBM 8KV, CDM 2KV
- Lead-Free SC70 Package Available

Applications

- Video Signal Amplification
- Set-Top Box Video Driver
- PVR、DVD Player Video Buffer
- Video Buffer for Portable or USB-Powered Video Devices
- HDTV

Description

TPF111 is a low-cost reconstruction video filter optimized for consumer video devices. With its exceptional video performance and very low power consumption, it is excellent choice for portable video applications. Integrated with a 6th-order Butterworth filter, TPF111 can be used as a DAC reconstruction filter or ADC anti-aliasing filter. With its -3dB frequency of 9MHz, it is an ideal choice for SD video applications including NTSC and PAL.

TPF111 accepts both AC- and DC-coupled inputs and its flexible biasing options meet the requirement of the most demanding applications. The integrated Transparent Sync-tip Clamp circuit restores DC voltage level of an AC-coupled Video signal. It translates the sync tip of a CVBS, Y', or RGB signal to a fixed 40mV. External biasing resistors can be used to restore signals without sync tip such as Pb' or Pr'. Integrated level shifter then raises the clamped video signal by 80mV, assuring passing through of video signal without being distorted. When the signal is DC-coupled, the level shifter will raise the signal by 80mV.

TPF111 may be used for different kinds of video buffering with 6dB gain(2V/V) and rail-to-rail output. It supports AC- and DC-coupling at the output.

TPF111 is designed to have exceptional ESD rating. It is a great choice of protecting the main video processor chip from ESD or surge strikes in applications such as set-top-boxes.

TPF111 operates from a single supply with wide voltage range from +2.85V to +5.5V. Its very low quiescent current of 3.85mA makes it an perfect choice for battery-power or USB-power applications.

TPF111 is available in SC70-5 package (TPF111-C) and SOIC-8 package (TPF111-S). Its operation temperature range is from -40°C to +85°C.

Related Resources

AN-1201: Application notes of TPF1xx

Function Block

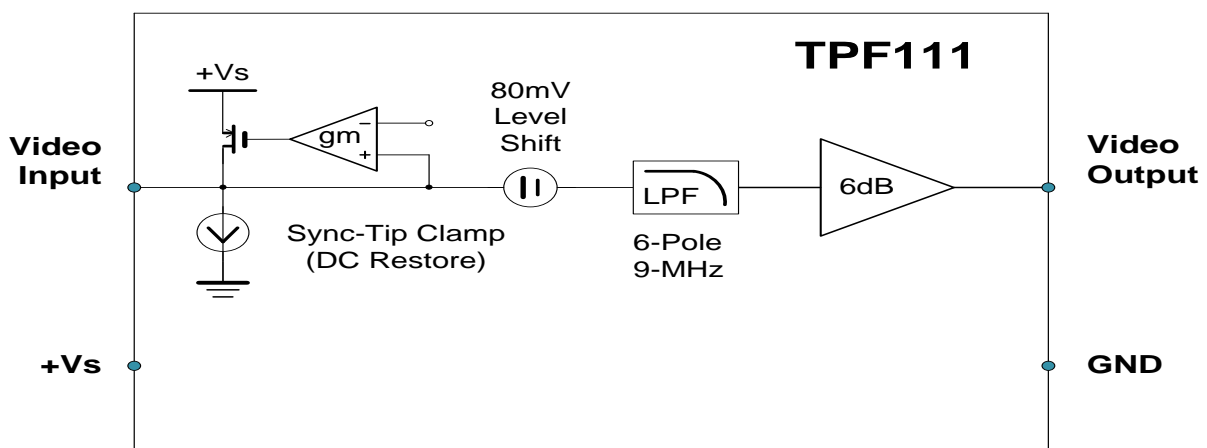

Order Information

Order Number	Marking Information	Operating Temperature Range	Package	Transport Media, Quantity
TPF111-CR	F1YW ⁽¹⁾	-40 to 85°C	5-Lead SC70	Tape and Reel, 3,000pcs
TPF111-SR	TPF111	-40 to 85°C	8-Lead SOIC	Tape and Reel, 4,000pcs
TPF111U-CR	F1UYW ⁽¹⁾	-40 to 85°C	5-Lead SC70	Tape and Reel, 3,000pcs
TPF111U-SR	TPF111U	-40 to 85°C	8-Lead SOIC	Tape and Reel, 4,000pcs

Note: (1). 'YW' is date coding scheme. 'Y' stands for calendar year, and 'W' stands for single workweek coding scheme.

Pin configuration (Top View)

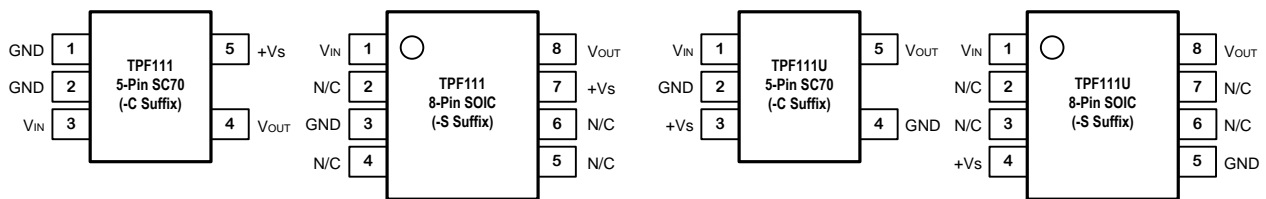

Pin Functions

SC70	SOIC	Pin Name	Function
3 / 1	1 / 1	V _{IN}	Video Input
	2, 4, 5, 6 / 2, 3, 6, 7	N/C	No Connect
1, 2 / 2, 4	3 / 5	GND	Ground
5 / 3	7 / 4	+V _S	Positive Power Supply
4 / 5	8 / 8	V _{OUT}	Filtered Video Output

Absolute Maximum Ratings^{Note}

Parameters		Value	Unit
Power Supply, V _{DD} to GND		6.0	V
PD	Power dissipation, T _A = 25°C, 5-Lead SC70	300 ⁽¹⁾	mW
	Power dissipation, T _A = 25°C, 8-Lead SOIC	800 ⁽¹⁾	
V _{IN}	Input Voltage	V _{DD} + 0.3V to GND - 0.3V	
I _o	Output Current	65	mA
T _J	Maximum Junction Temperature	150	°C
T _A	Operating Temperature Range	-45 to 85	°C
T _{STG}	Storage Temperature Range	-65 to 150	°C
TL	Lead Temperature (Soldering, 10 sec)	300	°C
θ _{JA}	5-Lead SC70	430 ⁽²⁾	°C/W
	8-Lead SOIC	130 ⁽²⁾	

(1) This data was taken with the JEDEC low effective thermal conductivity test board.

(2) This data was taken with the JEDEC standard multilayer test boards.

* **Note:** Stresses beyond those listed under Absolute Maximum Ratings may cause permanent damage to the device. Exposure to any Absolute Maximum Rating condition for extended periods may affect device reliability and lifetime.

ESD, Electrostatic Discharge Protection

Symbol	Parameter	Condition	Minimum Level	Unit
HBM	Human Body Model ESD	MIL-STD-883H Method 3015.8	8	kV
CDM	Charged Device Model ESD	JEDEC-EIA/JESD22-C101E	2	kV

Electrical Characteristics

All test condition is VDD = 3.3V, TA = +25°C, RL = 150Ω to GND, unless otherwise noted.

SYMBOL	PARAMETER	CONDITIONS	MIN	TYP	MAX	UNITS
Input Electrical Specifications						
V _{DD}	Supply Voltage Range		2.85		5.5	V
I _{DD}	Quiescent current (I _Q) ⁽¹⁾	V _{DD} = 3.3V, V _{IN} = 500mV, no load		3.85	4.85	mA
		V _{DD} = 5.0V, V _{IN} = 500mV, no load		5.00	6.25	mA
V _{CLAMP}	Input Voltage Clamp	I _{IN} = -100μA	-40	0	+40	mV
I _{CLAMP-CHG}	Clamp Charge Current	V _{IN} = V _{CLAMP} - 200mV	-1.5	-1.7		mA
I _{CLAMP-DCHG}	Clamp Discharge Current	V _{IN} = 500mV	1.5	2.0	5.1	μA
R _{IN}	Input Impedance	0.5V < V _{IN} < 1.0V	0.5	3		MΩ
AV	Voltage Gain ⁽¹⁾	V _{IN} =0.5V, 1V and 2V R _L = 150Ω to GND	5.9	6.01	6.025	dB
V _{OLS}	Output Level Shift Voltage	V _{IN} = 0V, no load, input referred	53	80	124	mV
V _{OH}	Output Voltage High Swing	V _{IN} = 3V, R _L = 150Ω to GND		3.18		V
V _{OL}	Output Voltage Low Swing	V _{IN} = -0.3V, R _L = 75Ω		0.05		V
PSRR	Power Supply Rejection Ratio	ΔV _{DD} = 3.3V to 3.6V		61		dB
		ΔV _{DD} = 5.0V to 5.5V, 50Hz, V _{IN} =0.7V		67		dB
I _{SC}	Short-circuit current	V _{IN} =2V, output to GND through 10Ω	65			mA
		V _{IN} =100mV, output short to V _{DD}	65			mA
AC Electrical Specifications						
f _{-1dB}	-1dB Bandwidth	R _L =150Ω	7.6	8.2	9.1	MHz
f _{-3dB}	-3dB Bandwidth	R _L =150Ω	7.8	9	10.5	MHz
Att _{27MHz}	Stop Band Attenuation	f = 27MHz	38.2	57.2	73.6	dB
dG	Differential Gain	Video input range 1V	-0.1	0.4	0.8	%
dP	Differential Phase	Video input range 1V	-1.1	0.7	1.1	°
THD	Output Distortion(All Channel)	f=1MHz, V _{OUT} =1.4V _{PP}	0.03	0.1	0.2	%
D/DT	Group Delay Variation	f = 100kHz, 5MHz		5.4		Ns
t _{PD}	Propagation Delay	Maximum delay from input to output: 100kHz to 4.43MHz	54	80	127	Ns
SNR	Signal-to-Noise Ration	f= 100kHz to 4.43MHz	65	69		dB
R _{OUT_AC}	Output Impedance	f = 4.2MHz		1.5		Ω
CLG	Chroma-Luma-Gain	400kHz to 3.58MHz and 4.43MHz		0.18	0.4	dB
CLD	Chroma-Luma-Delay	400kHz to 3.58MHz and 4.43MHz		5		ns

TPF111/TPF111U

Ultra-low Power, 1-Channel 6th-Order SD Video Filter Driver

Note: (1). 100% tested at $T_A=25^{\circ}\text{C}$.

Typical Performance Characteristics All test condition is $V_{DD} = 3.3V$, $T_A = +25^{\circ}C$, $R_L = 150\Omega$ to GND, unless otherwise noted.

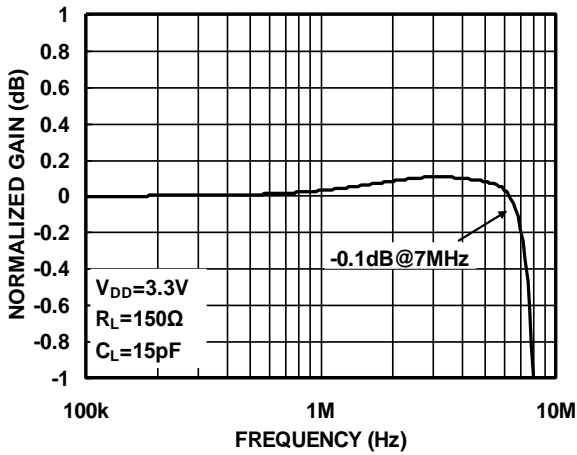

Figure1. Small-Scale Frequency Response

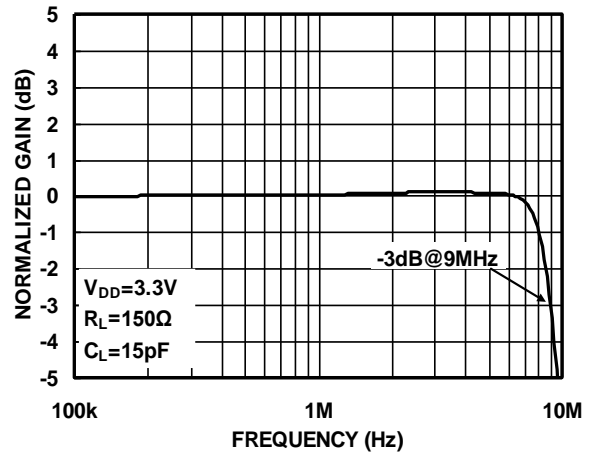

Figure2. Large-Scale Frequency Response

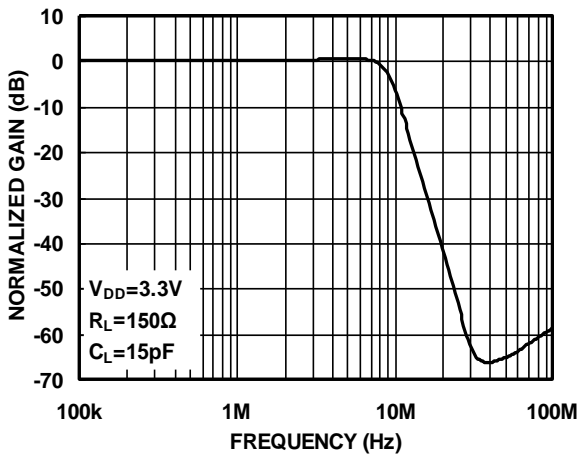

Figure3. Gain Vs. Frequency

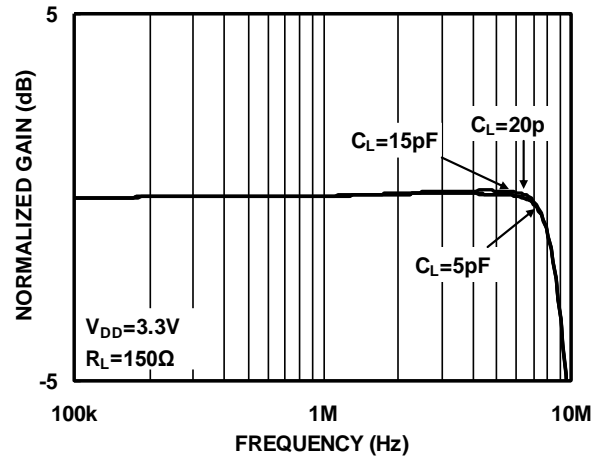

Figure4. Gain Vs. Frequency With C_{LOAD}

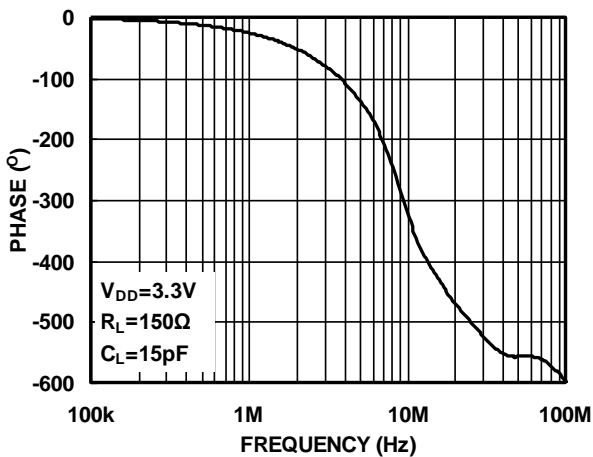

Figure5. Phase Vs. Frequency

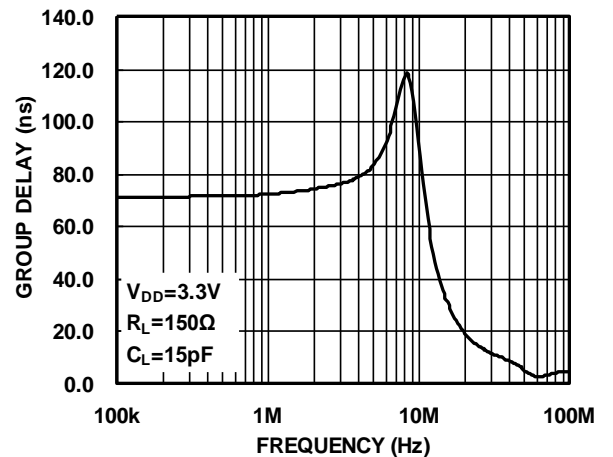

Figure6. Group Delay vs Frequency

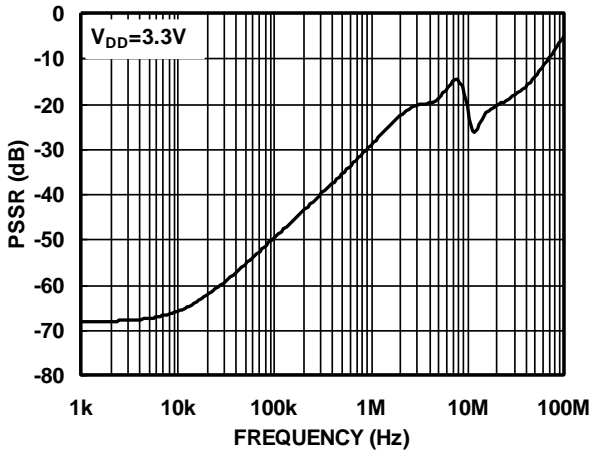

Figure7. PSRR Vs. Frequency

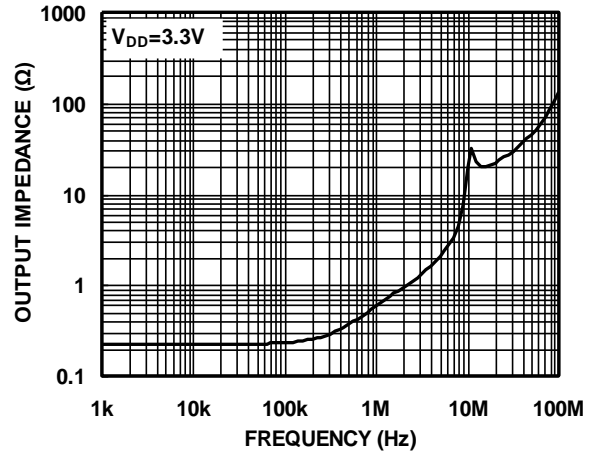

Figure8. Output Impedance Vs. Frequency

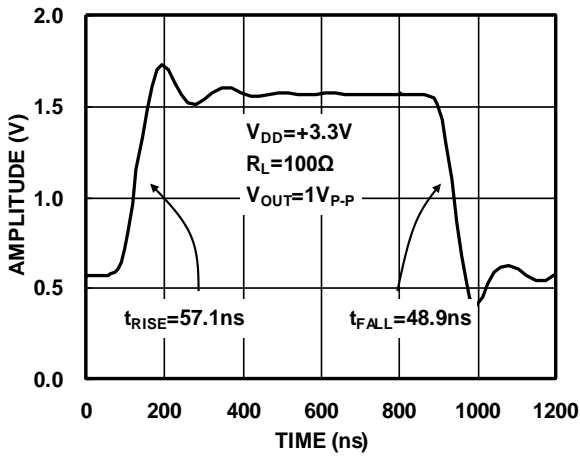

Figure9. Large-Signal Pulse Response Vs. Time

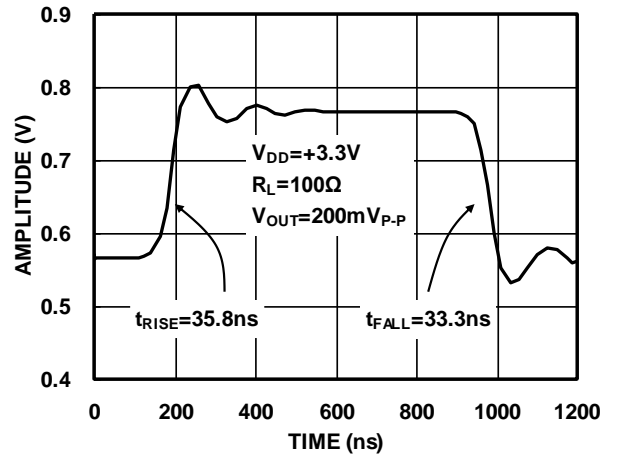

Figure10. Large-Signal Pulse Response Vs. Time

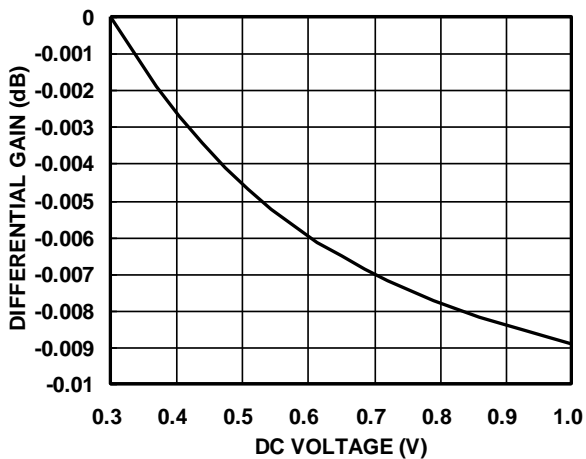

Figure11. Differential Gain(dG)

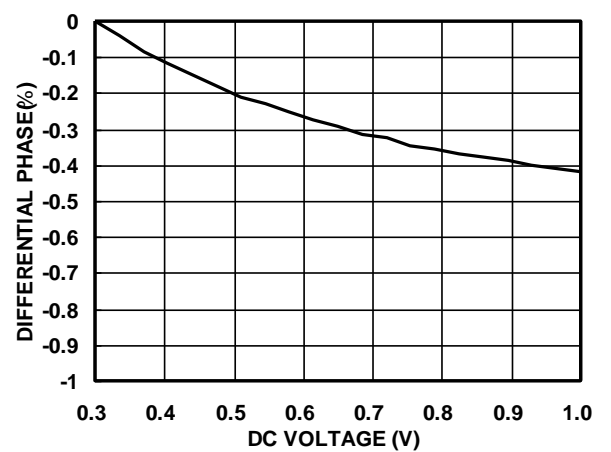

Figure12. Differential Phase(dP)

Application Information

The TPF111 is a single supply rail-to-rail output amplifier achieving a -3dB bandwidth of around 9MHz and slew rate of about 38V/ μ s while demanding only 3.85mA of supply current. This part is ideally suited for applications with specific micropower consumption and high bandwidth demands. As the performance characteristics above and the features described below, the TPF111 is designed to be very attractive for portable composite video applications.

Internal Sync Clamp

The typical embedded video DAC operates from a ground referenced single supply. This becomes an issue because the lower level of the sync pulse output may be at a 0V reference level to some positive level. The problem is presenting a 0V input to most single supply driven amplifiers will saturate the output stage of the amplifier resulting in a clipped sync tip and degrading the video image. A larger positive reference may offset the input above its positive range.

The TPF111 features an internal sync clamp and offset function to level shift the entire video signal to the best level before it reaches the input of the amplifier stage. These features are also helpful to avoid saturation of the output stage of the amplifier by setting the signal closer to the best voltage range.

The simplified block diagram of the TPF111 in Page-1. The AC coupled video sync signal is pulled negative by a current source at the input of the comparator amplifier. When the sync tip goes below the comparator threshold the output comparator is driven negative, The PMOS device turns on clamping sync tip to near ground level. The network triggers on the sync tip of video signal.

Droop Voltage and DC Restoration

Selection of the input AC-coupling capacitance is based on the system requirements. A typical sync tip width of a 64 μ s NTSC line is 4 μ s during which clamp circuit restores its DC level. In the remaining 60 μ s period, the voltage droops because of a small constant 2.0 μ A sinking current. If the AC-coupling capacitance is 0.1 μ F, the maximum droop voltage is

about 1mV which is restored by the clamp circuit. The maximum pull-up current of the clamp circuit is 1.7mA. For a 4 μ s sync tip width and 0.1 μ F capacitor, the maximum restoration voltage is about 80mV.

The line droop voltage will increase if a smaller AC-coupling capacitance is used. For the same reason, if larger capacitance is used the line droop voltage will decrease. Table 1 is droop voltage and maximum restoration voltage of the clamp for typical capacitance.

Table 1. Maximum restoration voltage and droop voltage of Y and CVBS signals for different capacitance

CAP VALUE (nF)	DROOP IN 60 μ s (mV)	CHARGE IN 4 μ s (mV)
100	1.2	68
1,000	0.12	6.8

Low Pass Filter--Sallen Key

The Sallen Key is a classic low pass configuration. This provides a very stable low pass function, and in the case of the TPF111, a six-pole roll-off at around 9MHz. The six-pole function is accomplished with an RC low pass network placed in series with and before the Sallen Key.

Output Couple

TPF111 output could support both "AC Couple" and "DC Couple", if use "AC Couple", this capacitor is typically between 220- μ F and 1000- μ F, although 470- μ F is common. This value of this capacitor must be this large to minimize the line tilt (droop) and/or field tilt associated with ac-coupling as described previously in this document.

The TPF111 internal sync clamp makes it possible to DC couple the output to a video load, eliminating the need for any AC coupling capacitors, thereby saving board space and additional expense for capacitors. This makes the TPF111 extremely attractive for portable video applications. Additionally, this solution completely eliminates the issue of field tilt in the lower frequency. The trade off is greater demand of supply current. Typical load current for AC coupled is around 1mA, compared to typical 6.6mA used when DC coupling.

Output Drive Capability and Power Dissipation

TPF111/TPF111U

Ultra-low Power, 1-Channel 6th-Order SD Video Filter Driver

With the high output drive capability of the TPF111, it is possible to exceed the +125°C absolute maximum junction temperature under certain load current conditions. Therefore, it is important to calculate the maximum junction temperature for an application to determine if load conditions or package types need to be modified to assure operation of the amplifier in a safe operating area. The maximum power dissipation allowed in a package is determined according to Equation:

$$PD_{MAX} = \frac{T_{JMAX} - T_{AMAX}}{\theta_{JA}}$$

Where:

T_{JMAX} = Maximum junction temperature

T_{AMAX} = Maximum ambient temperature

θ_{JA} = Thermal resistance of the package

The maximum power dissipation actually produced by an IC is the total quiescent supply current times the total power supply voltage, plus the power in the IC due to the load, or: for sourcing:

$$PD_{MAX} = V_s \times I_{SMAX} + (V_s - V_{OUT}) \times \frac{V_{OUT}}{R_L}$$

Where:

V_s = Supply voltage

I_{SMAX} = Maximum quiescent supply current

V_{OUT} = Maximum output voltage of the application

R_{LOAD} = Load resistance tied to ground

By setting the two PD_{MAX} equations equal to each other, we can solve the output current and R_{LOAD} to avoid the device overheat.

Power Supply Bypassing Printed Circuit Board Layout

As with any modern operational amplifier, a good printed circuit board layout is necessary for optimum performance. Lead lengths should be as short as possible. The power supply pin must be well bypassed to reduce the risk of oscillation. For normal single supply operation, a single 4.7µF tantalum capacitor in parallel with a 0.1µF ceramic capacitor from VS+ to GND will suffice.

VIDEO FILTER DRIVER SELECTION GUIDE

P/N	Product Description	Channel	-3dB Bandwidth	Package
TPF110	Low power, enable function and	1-SD	9MHz	SC70-5
/TPF110L	SAG correction, 1 channel 6 th order 9MHz			SOT23-6
TPF113	Low power 3 channel, 6th-order 9MHz SD video filter	3-SD	9MHz	SO-8
TPF114	Low power 4 channel, 6th-order 9MHz SD video filter	4-SD	9MHz	MSOP-10 TSSOP-14
TPF116	Low power 4 channel, 6th-order 9MHz SD video filter for CVBS, SVIDEO	6-SD	9MHz	TSSOP-14
TPF123	3 channel 6th-order 13.5MHz, 960H/720H-CVBS video filter or Y'Pb'Pr 480P/576P video filter	3-ED	13.5MHz	SO-8
TPF133	Low power 3 channel, 6th-order 36MHz HD video filter	3-HD	36MHz	SO-8
TPF134	Low power 3 channel, 6th-order 36MHz HD video filter and 1 channel SD video filter	1-SD& 3-SD	9MHz 36MHz	MSOP-10 TSSOP-14
TPF136	Low power 3 channel, 6th-order 36MHz HD video filter and 3 channel	3-SD& 3-HD	9MHz 36MHz	TSSOP-20

TPF111/TPF111U
Ultra-low Power, 1-Channel 6th-Order SD Video Filter Driver

SD video filter				
TPF143	Low power 3 channel, 6th-order 72MHz Full HD video filter	3-FHD	72MHz	SO-8
TPF144	Low power 3 channel, 6th-order 72MHz Full HD video filter and 1 channel SD video filter	1-SD& 3-FHD	9MHz 72MHz	MSOP-10 TSSOP-14
TPF146	Low power 3 channel, 6th-order 72MHz Full HD video filter and 3 channel SD video filter	3-SD& 3-FHD	9MHz 72MHz	TSSOP-20
TPF153	Low power 3 channel, 6th-order 220MHz Full HD video filter	3-CH	220MHz	SO-8

Package Outline Dimensions

SC70-5 /SOT-353

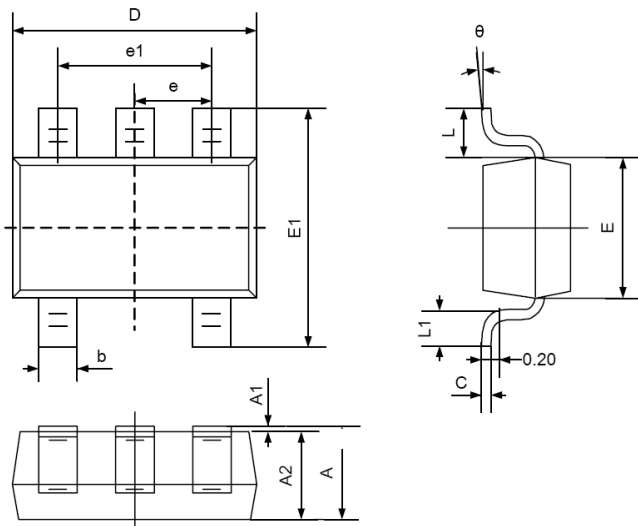

Symbol	Dimensions In Millimeters		Dimensions In Inches	
	Min	Max	Min	Max
A	0.900	1.100	0.035	0.043
A1	0.000	0.100	0.000	0.004
A2	0.900	1.000	0.035	0.039
b	0.150	0.350	0.006	0.014
C	0.080	0.150	0.003	0.006
D	2.000	2.200	0.079	0.087
E	1.150	1.350	0.045	0.053
E1	2.150	2.450	0.085	0.096
e	0.650TYP		0.026TYP	
e1	1.200	1.400	0.047	0.055
L	0.525REF		0.021REF	
L1	0.260	0.460	0.010	0.018
theta	0°	8°	0°	8°

SO-8

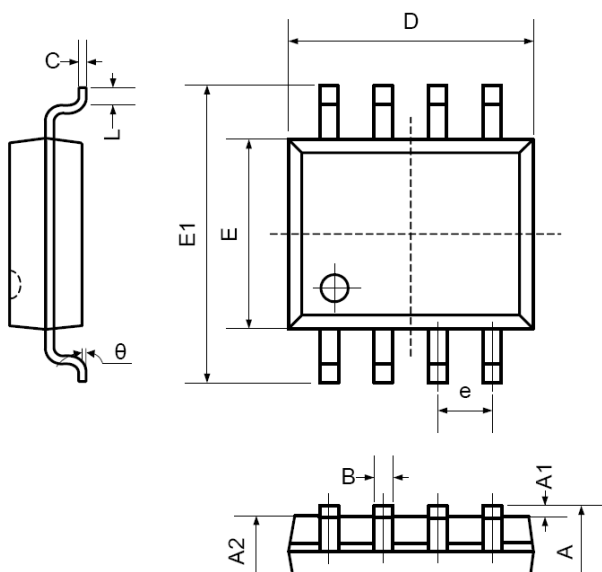

Symbol	Dimensions In Millimeters		Dimensions In Inches	
	Min	Max	Min	Max
A	1.350	1.750	0.053	0.069
A1	0.100	0.250	0.004	0.010
A2	1.350	1.550	0.053	0.061
B	0.330	0.510	0.013	0.020
C	0.190	0.250	0.007	0.010
D	4.780	5.000	0.188	0.197
E	3.800	4.000	0.150	0.157
E1	5.800	6.300	0.228	0.248
e	1.270TYP		0.050TYP	
L1	0.400	1.270	0.016	0.050
theta	0°	8°	0°	8°

IMPORTANT NOTICE AND DISCLAIMER

Copyright© 3PEAK 2012-2023. All rights reserved.

Trademarks. Any of the 思瑞浦 or 3PEAK trade names, trademarks, graphic marks, and domain names contained in this document /material are the property of 3PEAK. You may NOT reproduce, modify, publish, transmit or distribute any Trademark without the prior written consent of 3PEAK.

Performance Information. Performance tests or performance range contained in this document/material are either results of design simulation or actual tests conducted under designated testing environment. Any variation in testing environment or simulation environment, including but not limited to testing method, testing process or testing temperature, may affect actual performance of the product.

Disclaimer. 3PEAK provides technical and reliability data (including data sheets), design resources (including reference designs), application or other design recommendations, networking tools, security information and other resources "As Is". 3PEAK makes no warranty as to the absence of defects, and makes no warranties of any kind, express or implied, including without limitation, implied warranties as to merchantability, fitness for a particular purpose or non-infringement of any third-party's intellectual property rights. Unless otherwise specified in writing, products supplied by 3PEAK are not designed to be used in any life-threatening scenarios, including critical medical applications, automotive safety-critical systems, aviation, aerospace, or any situations where failure could result in bodily harm, loss of life, or significant property damage. 3PEAK disclaims all liability for any such unauthorized use.