

Features

- Internal Precision Voltage Reference
 - ◆ Accuracy: 0.2% (max)
 - ◆ Temp Drift: 50ppm (max)
 - ◆ Pin Selectable for 2.5V, 1.65V, and Ratio Metric
- Switching Current HALL Sensor Excitation
 - ◆ Reduce HALL Sensor Offset and Drift
 - ◆ Reduce HALL Sensor 1/f Noise
- Extended Current Measurement Range
 - ◆ H-Bridge Drive Capability: 350 mA
- Precision Current Sensing Amplifier
 - ◆ Offset and Drift: 100μV and 2μV/°C (Max)
 - ◆ Bandwidth: 200kHz
- Overrange and Error Flags
- Power Supply: 2.7V to 5.5V
- Package: QFN 4mm x 4mm with PowerPAD
- Temp Range: -40°C to +125°C

Applications

- Close-Loop HALL Sensor Module

Description

The TPAFE411 is designed only for Hall elements to use in closed-loop current-sensor modules. The internal precision excitation circuitry for the Hall-element could effectively eliminate the offset and offset-drift of the Hall element. The TPAFE411 also provides a 350mA H-bridge for driving the sensor compensation coil, and an internal precision current sensing amplifier to generate the output signal.

There is a high accuracy voltage reference, high accuracy HALL Sensor front end and precision current sensing amplifier inside TPAFE411. These techniques significantly improve the accuracy of the overall current-sensor module. When the power supply is 5V, the output voltage is pin-selectable to support a 2.5V output. When the power supply is 3.3V, the output voltage is to support a 1.65V output.

For the heat dissipation, 4mm × 4-mm QFN package with PowerPAD is selected for the TPAFE411. The TPAFE411 is specified to work over industrial temperature range of -40°C to +125°C.

Function Block Diagram

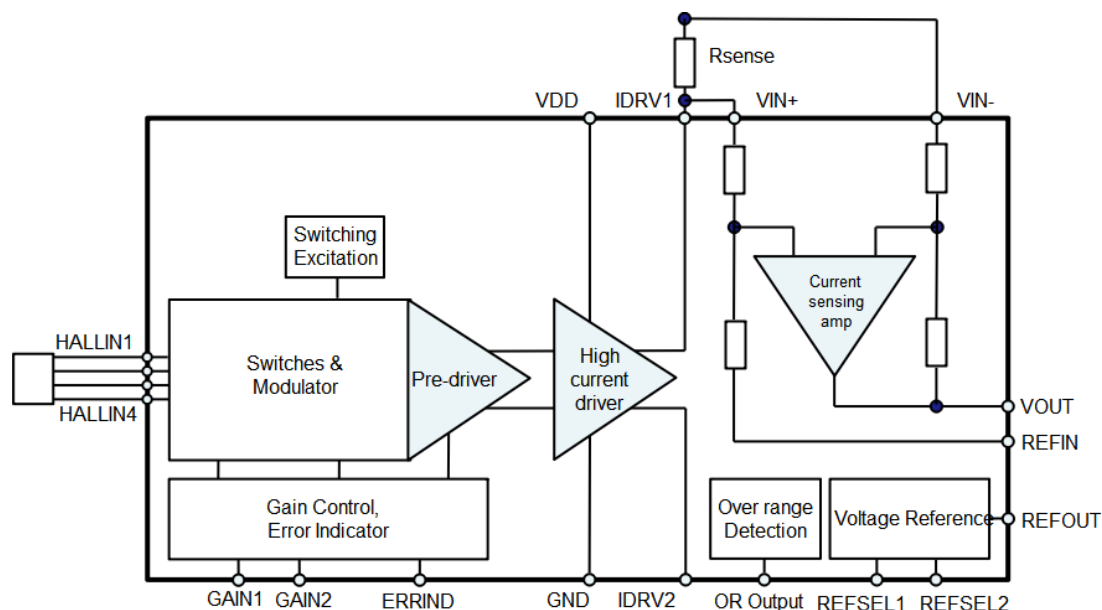

Table of Contents

Features	1
Applications	1
Description	1
Function Block Diagram	1
Table of Contents	2
Revision History	3
Pin Configuration and Pin Functions	4
Pin Functions	4
Order Information	5
Specifications	5
Absolute Maximum Ratings*	5
ESD, Electrostatic Discharge Protection	5
Thermal Information	5
Electrical Characteristics	6
Typical Performance Characteristics	9
Application Information	13
Shunt sense amplifier	13
Overage comparator	13
Voltage reference	13
Reference output voltage selection	14
Power-On startup and brownout	14
Error condition	14
Protection recommendations	14
TAPE AND REEL INFORMATION	15
Package Outline Dimensions	16
QFN4X4-20	16
IMPORTANT NOTICE AND DISCLAIMER	17

Revision History

Date	Revision	Notes
2020/4/25	Rev.Pre.0	Pre-Release Version
2021/5/16	Rev.Pre.1	Pre-Release Version 1
2021/6/2	Rev.A.0	Release Version
2021/12/1	Rev.A.1	Update Electrical Characteristics table, fix typos

Pin Configuration and Pin Functions

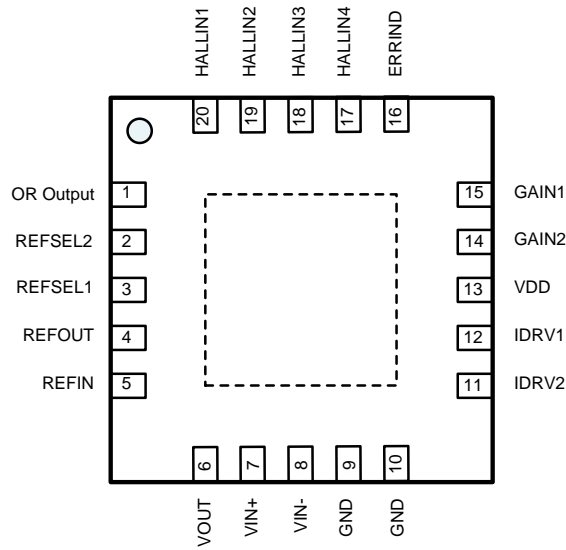

Pin Functions

PIN Number	PIN Name	Description
1	OR Output	Open-drain output for overrange indication
2	REFSEL2	Reference mode select
3	REFSEL1	Reference mode select
4	REFOUT	Output for selected reference voltage
5	REFIN	Input for reference of current sensing amplifier
6	VOUT	Output of current sensing amplifier
7	VIN+	Noninverting input of current sensing amplifier
8	VIN-	Inverting input of current sensing amplifier
9	GND	Ground
10	GND	Ground
11	IDRV2	Output 2 of compensation coil driver
12	IDRV1	Output 1 of compensation coil driver
13	VDD	Power supply
14	GAIN2	Gain selected for HALL amplifier
15	GAIN1	Gain selected for HALL amplifier
16	ERRIND	Open-drain output for error indication
17	HALLIN4	Pin 4 of HALL sensor
18	HALLIN3	Pin 3 of HALL sensor
19	HALLIN2	Pin 2 of HALL sensor
20	HALLIN1	Pin 1 of HALL sensor
Thermal PAD		Connected ground

Order Information

Order Number	Operating Temperature Range	Package	Marking Information	MSL	Transport Media, Quantity
TPAFE411-QFOR	-40 to 125°C	QFN4X4-20	FE411	3	3000

Specifications

Absolute Maximum Ratings*

Parameters	Value	Unit
Power Supply, V_{DD} to GND	6.0	V
Input Voltage	GND – 0.3 to V_{DD} + 0.3	V
Maximum Junction Temperature, T_J	150	°C
Operating Temperature Range, T_A	-40 to 125	°C
Storage Temperature Range, T_{STG}	-65 to 150	°C
Lead Temperature (Soldering 10 sec), T_L	300	°C

* **Note:** Stresses beyond those listed under Absolute Maximum Ratings may cause permanent damage to the device. Exposure to any Absolute Maximum Rating condition for extended periods may affect device reliability and lifetime.

ESD, Electrostatic Discharge Protection

Symbol	Parameter	Condition	Minimum Level	Unit
HBM	Human Body Model ESD	ANSI/ESDA/JEDEC JS-001	5	kV
CDM	Charged Device Model ESD	ANSI/ESDA/JEDEC JS-002	1.5	kV

Thermal Information

Package Type	θ_{JA}	θ_{JC}	Unit
QFN4X4-20	34	35	°C/W

Electrical Characteristics

All test condition is VDD = +2.7 V to +5.5 V, T_A = +25°C, zero output current IDR_V, unless otherwise noted.

Symbol	Parameter	Conditions	Min	Typ	Max	Unit
HALL Sensor Excitation						
V _{EX}	HALL sensor excitation voltage	GAIN [00, 01, 10]	0.7	0.8	0.95	V
		GAIN [11]	0.6	0.74	0.95	V
I _{EX}	HALL sensor excitation current	T _A = -40°C to 125°C			10	mA
f _{switch}	Excitation switching frequency			1		MHz
AOL _{FB}	Front-end open-loop flat band gain	GAIN [00], f _{zero} = 3.8kHz		250		V/V
		GAIN [01], f _{zero} = 7.2kHz		250		V/V
		GAIN [10], f _{zero} = 3.8kHz		1000		V/V
AOL	Front-end open-loop gain	GAIN [00, 01, 10, 11]	91	120		dB
V _{OS_FE}	Front end input voltage offset	No HALL sensor, GAIN [00, 01, 10]		20	100	μV
		GAIN [11]		5	12	mV
V _{OS_FE TC}	Front end input voltage offset drift	No HALL sensor, GAIN [00, 01, 10]		0.2		μV/°C
		GAIN [11]		5		μV/°C
GBWP	Gain bandwidth product	GAIN [11]		14		MHz
CMRR	Common mode rejection ration	GAIN [11]		300		μV/V
	Error comparator threshold			50		mV

Electrical Characteristics (Continued)
All test condition is VDD = +2.7 V to +5.5 V, TA = +25°C, zero output current IDR_V, unless otherwise noted.

Symbol	Parameter	Conditions	Min	Typ	Max	Unit
Current Sensing Amplifier						
V _{OS}	Input voltage offset, RTO	V _{IN+} =V _{IN-} =V _{REFIN}		0.01	0.2	mV
V _{OS} TC	Input voltage offset drift, RTO	V _{IN} =0.5V, 1V or 2V, T _A = -40°C to 125°C		0.4		μV/°C
CMRR	vs common mode voltage, RTO	V _{CM} = -1V to V _{DD} +1V, V _{REF} = V _{DD} / 2,		50	500	μV/V
PSRR	vs Power supply, RTO	V _{CM} = V _{REFIN}		4	50	μV/V
V _{CM}	Common mode input range		-1		V _{DD} + 1	V
	Differential impedance			12		kΩ
	Common impedance			22		kΩ
	External reference input impedance		36	44	52	kΩ
G	Gain, V _{OUT} / V _{IN,DIFF}			4		V/V
GE	Gain error			0.02	0.3	%
	Gain error drift			1		ppm/°C
V _{OL}	Voltage output swing to ground	I = 2.5mA, comparator trip level		50	150	mV
V _{OH}	Voltage output swing to power supply	I = -2.5mA, comparator trip level	V _{DD} -150	V _{DD} -50		mV
I _{SC}	Short circuit current	V _{OUT} connected to GND		-18		mA
		V _{OUT} connected to power supply		20		mA
	Signal overrange indicator delay	V _{IN} = 1V step		3		μs
BW _{-3dB}	Bandwidth			2		MHz
SR	Slew rate			11		V/μs
	Setting time large signal	ΔV = 2V to 1%		4		μs
	Setting time	ΔV = 0.4V to 0.01%		15		μs
e _n	Output voltage noise, RTO	f = 1kHz		150		nV/√Hz
Compensation Coil Driver						
	Peak current	V _{DD} = 5V, T _A = -40°C to 125°C, V _{IDRV1} - V _{IDRV2} = 4.2V _{pp}	300	350		mA
		V _{DD} = 3.3V, T _A = -40°C to 125°C, V _{IDRV1} - V _{IDRV2} = 2.5V _{pp}	150	200		mA
	Voltage swing	V _{DD} = 5V, R _{LOAD} = 14Ω	4.2			V _{pp}
		V _{DD} = 3.3V, R _{LOAD} = 14Ω	2.5			V _{pp}
	Output common mode			V _{DD} / 2		V

Electrical Characteristics (Continued)

All test condition is VDD = +2.7 V to +5.5 V, TA = +25°C, zero output current IDR_V, unless otherwise noted.

Symbol	Parameter	Conditions	Min	Typ	Max	Unit
Voltage Reference						
V _{REF}	Reference voltage	REFSEL [00]	2.495	2.500	2.505	V
		REFSEL [10]	1.648	1.651	1.654	V
		REFSEL [11]	49.6	50	50.4	% V _{DD}
	Reference voltage drift	REFSEL [00, 10]		5	50	ppm/°C
	Voltage divider gain error drift	REFSEL [11]		5		ppm/°C
PSRR	Power supply rejection ration	REFSEL [00, 10]		15	200	μV/V
	Load regulation	Load to ground or VDD		0.15	0.35	mV/mA
I _{SC}	Short circuit current	REFOUT connected to GND		-18		mA
		REFOUT connected to VDD		20		mA
Digital Input / Output						
V _{IH}	High level input voltage		0.7 x V _{DD}		V _{DD} + 0.3	V
V _{IL}	Low level input voltage		-0.3		0.3 x V _{DD}	V
V _{OL}	Low level output voltage	4mA sink		0.3		V
Power Supply						
V _{DD}	Power supply		2.7		5.5	V
I _Q	Quiescent current	I _{DRV} = 0mA		5.5	8	mA
V _{RST}	Power on reset threshold			2.4		V
Temperature						
	Specified range		-40		125	°C
	Operating range		-50		150	°C

Typical Performance Characteristics

All test condition is VDD = 5.0V, TA = +25°C, unless otherwise noted.

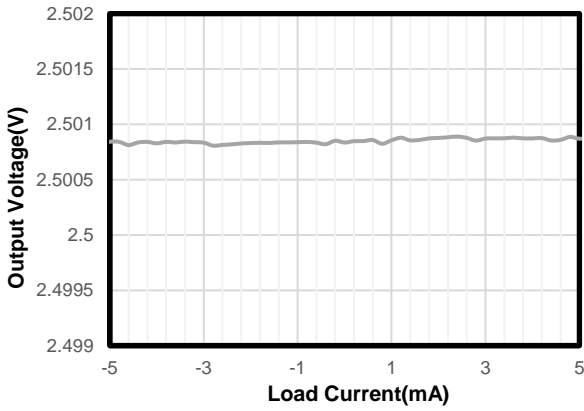

2.5-V REFERENCE OUTPUT VOLTAGE vs LOAD

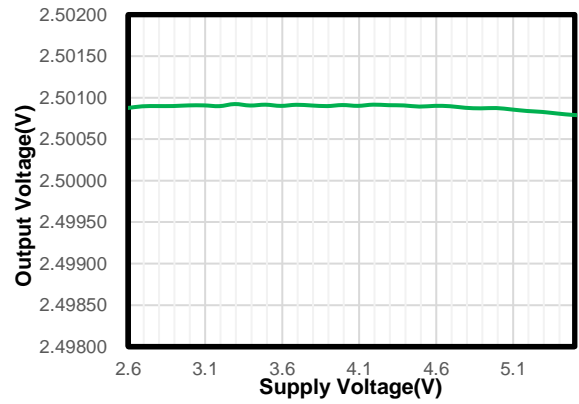

2.5-V REFERENCE OUTPUT VOLTAGE vs Supply Voltage

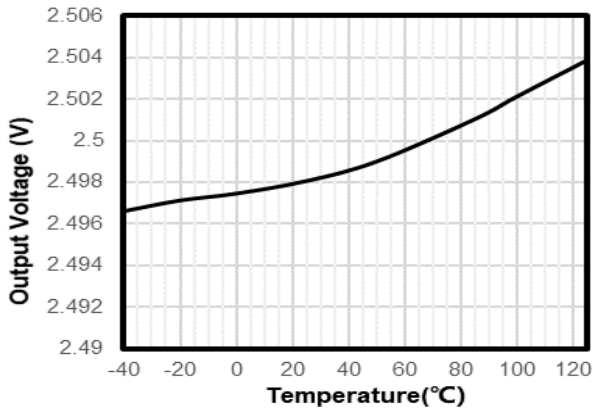

2.5-V REFERENCE OUTPUT VOLTAGE vs TEMPERATURE

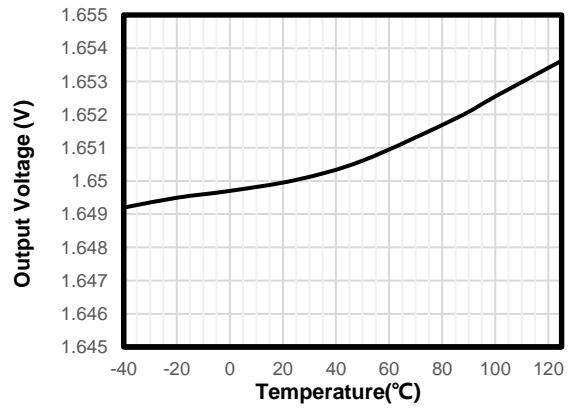

1.65-V REFERENCE OUTPUT VOLTAGE vs TEMPERATURE

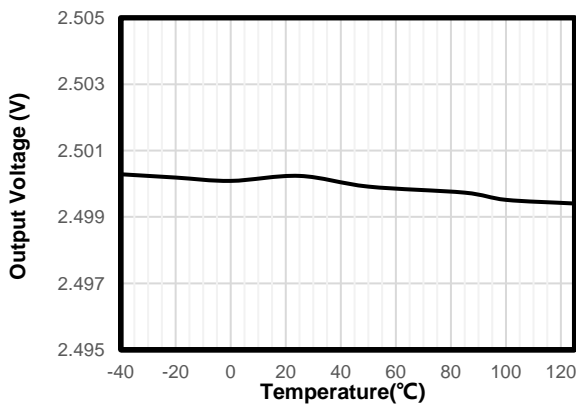

RATIOMETRIC REFERENCE OUTPUT VOLTAGE vs TEMPERATURE

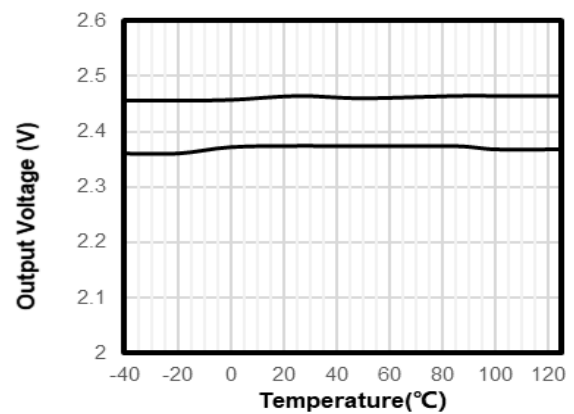

POWER-ON-RESET vs TEMPERATURE

Typical Performance Characteristics (Continued)

All test condition is VDD = 5.0V, TA = +25°C, unless otherwise noted.

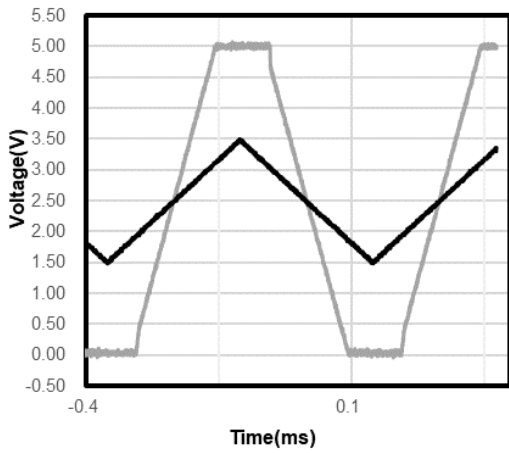

DIFFERENTIAL AMPLIFIER OVERLOAD RECOVERY

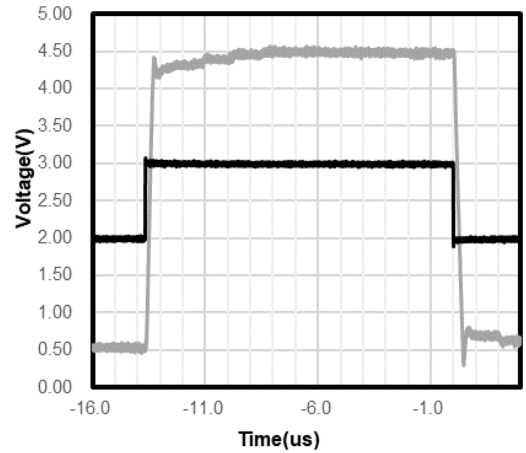

DIFFERENTIAL AMPLIFIER STEP RESPONSE

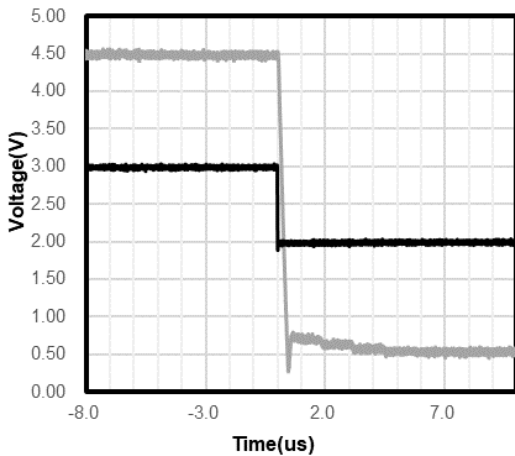

DIFFERENTIAL AMPLIFIER SETTLING TIME(FALLING EDGE)

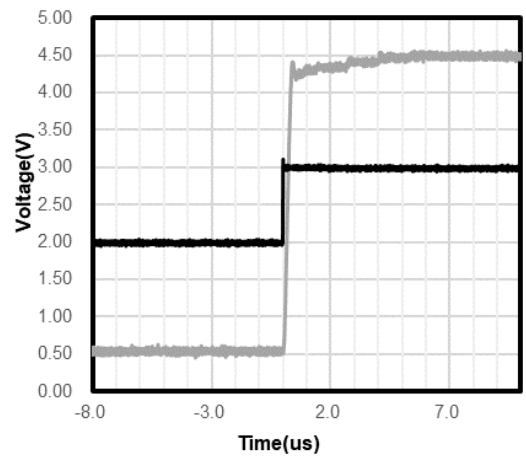

DIFFERENTIAL AMPLIFIER SETTLING TIME (RISING EDGE)

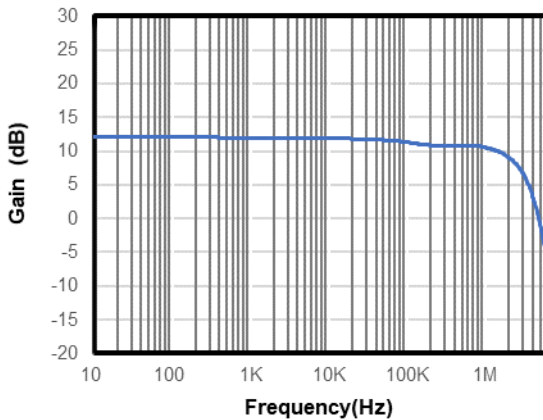

DIFFERENTIAL AMPLIFIER GAIN vs FREQUENCY

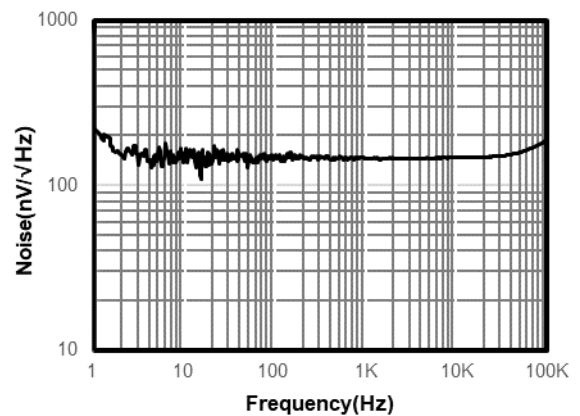

DIFFERENTIAL AMPLIFIER OUTPUT VOLTAGE NOISE DENSITY

Typical Performance Characteristics (Continued)

All test condition is VDD = 5.0V, TA = +25°C, unless otherwise noted.

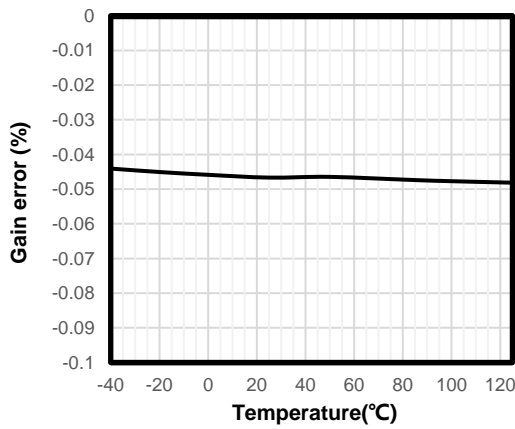

DIFFERENTIAL AMPLIFIER GAIN ERROR vs TEMPERATURE

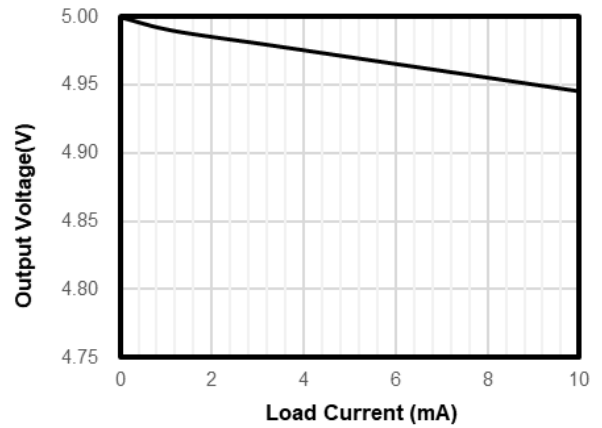

DIFFERENTIAL AMPLIFIER OUTPUT VOLTAGE vs OUTPUT CURRENT (POSITIVE RAIL)

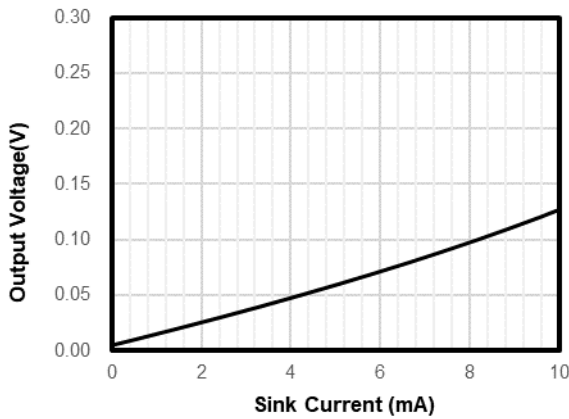

DIFFERENTIAL AMPLIFIER OUTPUT VOLTAGE vs OUTPUT CURRENT (NEGATIVE RAIL)

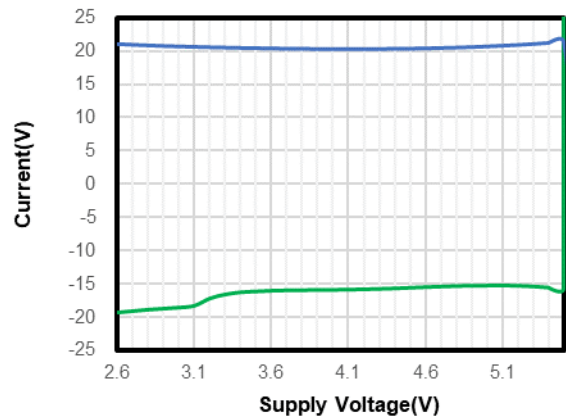

DIFFERENTIAL AMPLIFIER SHORT-CIRCUIT CURRENT vs POWER SUPPLY

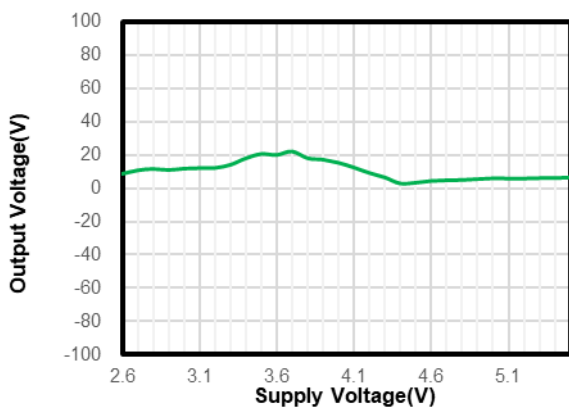

DIFFERENTIAL AMPLIFIER OFFSET VOLTAGE vs POWER SUPPLY

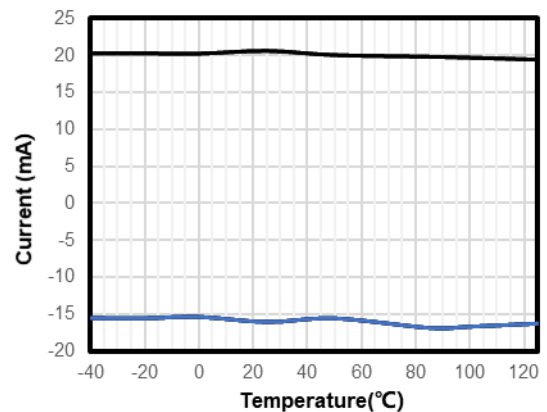

DIFFERENTIAL AMPLIFIER SHORT-CIRCUIT CURRENT vs TEMPERATURE

Typical Performance Characteristics (Continued)

All test condition is VDD = 5.0V, TA = +25°C, unless otherwise noted.

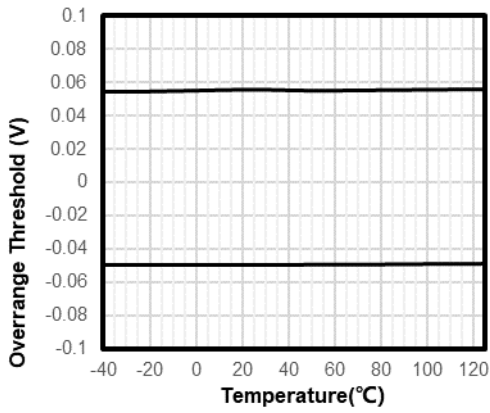

OVERRANGE TRIP LEVEL vs TEMPERATURE

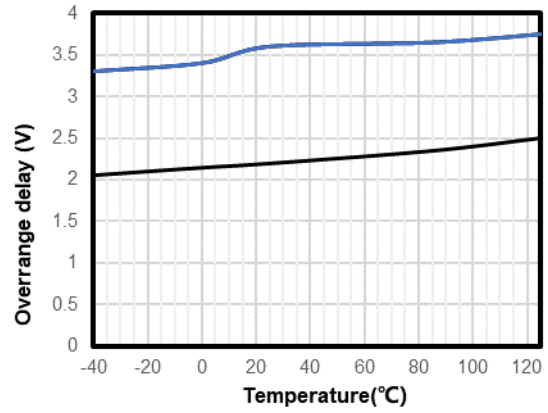

OVERRANGE DELAY vs TEMPERATURE

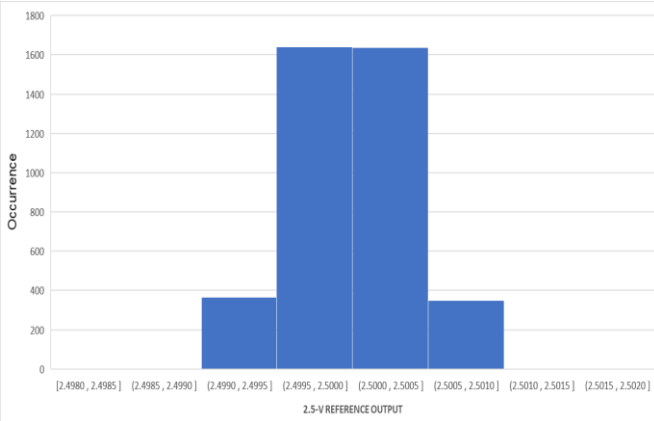

2.5-V REFERENCE OUTPUT VOLTAGE HISTOGRAM

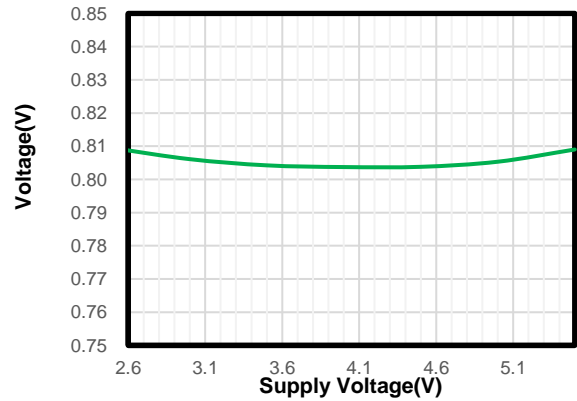

HALL SENSOR EXCITATION VOLTAGE

Application Information

TPAFE411 is a signal sensor conditional circuit used to connect current sensor and giving the necessary functions for the sensor operation. The power supply of TPAFE411 is from single +2.7V to +5.5V. And this device includes the basic functions such as magnetic field probe (HALL sensor) excitation, signal conditioning, compensation-coil driver amplification, error condition detecting, and capability of fixing overload circumstance. A precision differential amplifier is embedded to convert the compensation current into output voltage with a shunt resistor. The device also has a precise voltage reference which supplies voltage to comparator, analog-to-digital converter (ADC). A dynamic error correction module is designed to make sure the device keeps the high dc precision and long-term accuracy over the temperature.

The TPAFE411 contains an internal clock and counter logic for managing power-up, overload detection and recovery, error, and time-out situations. In addition, the fabrication of CMOS process makes the TPAFE411 highly reliable.

Shunt sense amplifier

To compensate coil of the differential (H-bridge) driver, a differential sense amplifier was required for the shunt voltage. The differential amplifier is designed with wide bandwidth and high slew rate for fast current sensors. chopping is also designed for minimizing the system offset. For gains of 4 V/V, $R2/R1=4$.

Both inputs of the differential amplifier are tied to the current shunt resistor. This shunt resistor will slight reduce the gain of the amplification circuit and common-mode rejection (CMR). So, a dummy shunt resistor was added in series with the REFIN pin to re-establish the matching of both input impedance for the gain of amplification.

Generally, the gain error contributed by the resistance of R-shunt is negligible, but the matching for both resistor divider ratios should be at least higher than 1/3000 for 70dB common-mode rejection.

The output of amplifier drives the input of a Sar-type ADC with an RC low-pass filter. This filter is required to filter out high-frequency component from the amplifier output. For R_f and C_f values, optimum values could be obtained by experiments.

The REFIN pin is the reference node for the output signal (VOUT). The zero reference voltage could be achieved by connecting REFIN to the reference output (REFOUT). The common reference for ADC and TPAFE411 should be used for avoiding the mismatch errors between two reference sources.

Overage comparator

If there is an overload current flowing the shunt resistor, the OR pin will be pulled low to indicate an overvoltage condition for the differential amplifier. The output pin will hold 3us before flip-flop in case the noise triggers the flag. The OR pin will return to high as no overload current exists. This error flag will warn system to shut down the circuit. And the shunt resistor value defines the working condition of current sets the ratio between the nominal signal and triggered level of the overload flag. This trip current is calculated with following examples:

The output voltage swing is approximately ± 2.45 V (load and supply voltage-dependent) at a 5-V supply. Divide by the gain of 4 V/V, an input swing is ± 0.6125 V, and the clipping current is $I_{MAX} = 0.6125$ V / RSHUNT.

The over range condition is measured immediately when amplifier approaches the rail and exceeds the linear operating range. Therefore, the error flag of the over range comparator level can indicate the fault circumstances such as output shorts, low load, or low-supply conditions. The flag signal will keep active if the output can't drive the voltage higher.

Voltage reference

The precise voltage reference supplies low drift voltage and is used to bias the internal circuit, it is also tied to the REFOUT pin. The circuit works as the reference point of the output signal to allow a bipolar signal around it. The output has the internal buffer for low impedance and allows maximum ± 5 mA current to be sank or sourced.

Capacitive loads can be connected directly but may have the ringing for fast load transients. To achieve the better transient response, a small series resistor can be placed in series.

Reference output voltage selection

As shown below, the 5V and 3.3V power supplies are usually selected for the TPAFE411. The sensor output must be set at 2.5V and 1.65V, respectively. The internal reference gives the low drift and precise reference voltage.

MODE	REFSEL1	REFSEL2	DESCRIPTION
REF = 2.5 V	0	0	Used with sensor module supply of 5 V
REF = 1.65 V	1	0	Used with sensor module supply of 3.3 V
Ratio-metric output	1	1	Provides output centered on $V_S / 2$

For the ratio-metric mode, the reference is bypassed, and the power supply is divided by two. The internal resistor divider gives a very good temperature coefficient which is less than 10ppm/. And the sensor output is around $V_S/2$ in this case.

Power-On startup and brownout

Power-on is activated when the power supply goes above 2.4V. At this point, digital logic begins to work and waits for 100us for power supply to settle. During this time, ICOMP1 and ICOMP2 outputs are pulled down to low in order that there is no undesired signal driving the compensation coil. The ERROR pin will hold low for 100us when error happens in case that false error triggers the output. VOUT will be only valid for 100us after power-on reset.

The brownout voltage level of TPAFE411 is around 2.4V. Bypass capacitors and stable power supply are required for driving the heavy current by TPAFE411. The supply voltage drop that lasts longer than 25us will activate the power-on reset. If the voltage drops below 1.8V, the power-on reset will be also triggered. When the power supply returns to 2.4V, the device will restart the startup process as described above.

Error condition

If there is a signal clipping in the differential amplifier, the over range flag will be activated. It will also trigger the system error flag. This error points out that the output voltage does not represent the primary current. The error flag is activated when the power fails and browns out or Hall sensor is not within its normal operating range.

Both error and over range flags are based on the open-drain circuit, an external pull-up resistor is required.

The conditions listed below will activate the error flag:

1. The Hall sensor offset was bigger than 50mV.
2. Any terminal of Hall sensor is disconnected.

Protection recommendations

The inputs IAIN1 and IAIN2 need external protection to limit the voltage swing below 6 V of the voltage supply. ICOMP1 and ICOMP2 can afford high-current pulse due to internal clamp circuit. Schottky diodes should be connected to the supply rail when large currents are expected.

TAPE AND REEL INFORMATION

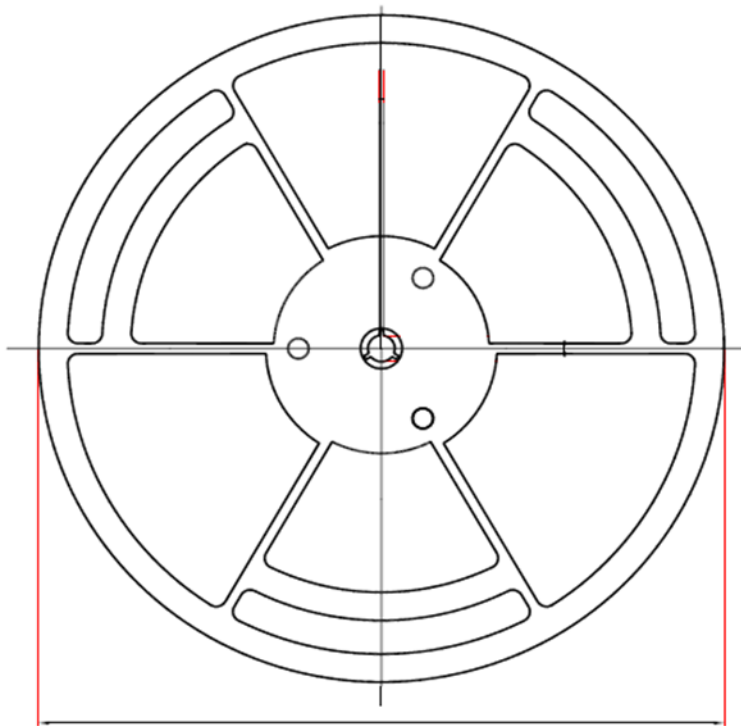

D1: Reel Diameter

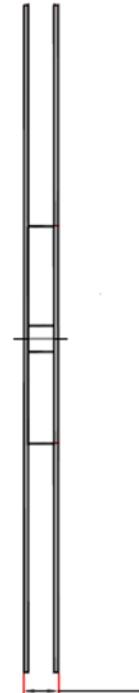

W1: Reel Width

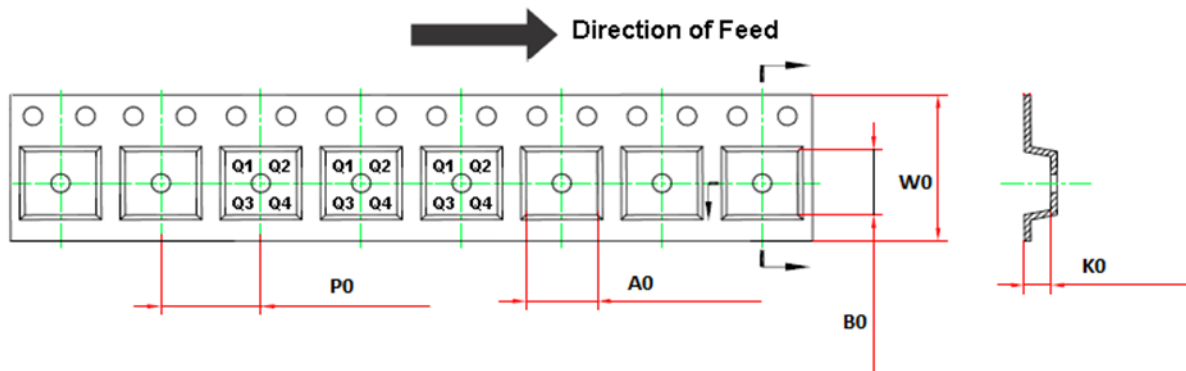

Order Number	Package	D1 (mm)	W1 (mm)	A0 (mm)	B0 (mm)	K0 (mm)	P0 (mm)	W0 (mm)	Pin1 Quadrant
TPAFE411-QFOR	QFN4X4-20	330.0	17.6	4.3	4.3	1.1	8	12.0	Q2

Package Outline Dimensions

QFN4X4-20

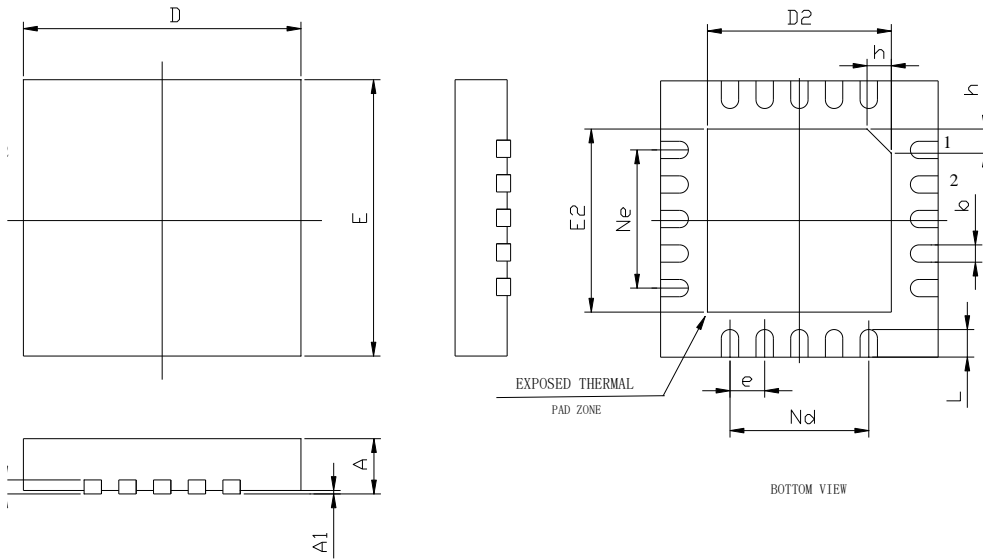

SYMBOL	MILLIMETER		
	MIN	NDM	MAX
A	0.70	0.75	0.80
A1	--	0.02	0.05
b	0.18	0.25	0.30
c	0.18	0.20	0.25
D	3.90	4.00	4.10
D2	2.55	2.65	2.75
e	0.50BSC		
Ne	2.00BSC		
Nd	2.00BSC		
E	3.90	4.00	4.10
E2	2.55	2.65	2.75
L	0.35	0.40	0.45
h	0.30	0.35	0.40
L/F 载体尺寸 (mm)	114X114		

IMPORTANT NOTICE AND DISCLAIMER

Copyright© 3PEAK 2012-2023. All rights reserved.

Trademarks. Any of the 思瑞浦 or 3PEAK trade names, trademarks, graphic marks, and domain names contained in this document /material are the property of 3PEAK. You may NOT reproduce, modify, publish, transmit or distribute any Trademark without the prior written consent of 3PEAK.

Performance Information. Performance tests or performance range contained in this document/material are either results of design simulation or actual tests conducted under designated testing environment. Any variation in testing environment or simulation environment, including but not limited to testing method, testing process or testing temperature, may affect actual performance of the product.

Disclaimer. 3PEAK provides technical and reliability data (including data sheets), design resources (including reference designs), application or other design recommendations, networking tools, security information and other resources "As Is". 3PEAK makes no warranty as to the absence of defects, and makes no warranties of any kind, express or implied, including without limitation, implied warranties as to merchantability, fitness for a particular purpose or non-infringement of any third-party's intellectual property rights. Unless otherwise specified in writing, products supplied by 3PEAK are not designed to be used in any life-threatening scenarios, including critical medical applications, automotive safety-critical systems, aviation, aerospace, or any situations where failure could result in bodily harm, loss of life, or significant property damage. 3PEAK disclaims all liability for any such unauthorized use.