

Features

- Supply Voltage: 8 V to 36 V
- Offset Voltage: ± 3 mV
- Differential Input Voltage Range to Supply Rail, can Work as Comparator
- Bandwidth: 20 MHz, Slew Rate: 10 V/ μ s
- Low Noise:
 - Voltage Noise Density: 10 nV/ $\sqrt{\text{Hz}}$ at 100 Hz
 - 0.1 to 10 Hz Voltage Noise: 0.8 μ V_{PP}
- Input Rail to $-V_s$, No Internal ESD Diode to $+V_s$
- High PSRR+: 80 dB at 100 kHz
- -40°C to 125°C Operation Temperature Range

Applications

- Instrumentation
- Active Filters, ASIC Input or Output Amplifier
- Sensor Interface
- Industrial Control
- Audio Application

Description

The TPA268X series amplifiers are the newest high-supply voltage amplifiers with low noise and high-frequency response. They incorporate 3PEAK's proprietary and patented design techniques to achieve very good AC performance with 20MHz bandwidth, 10 V/ μ s slew rate, and low distortion while drawing only 6mA of quiescent current per amplifier.

The combination of features makes the TPA268X an ideal choice for industrial control, motor control and audio amplification, sound ports, and other consumer audio.

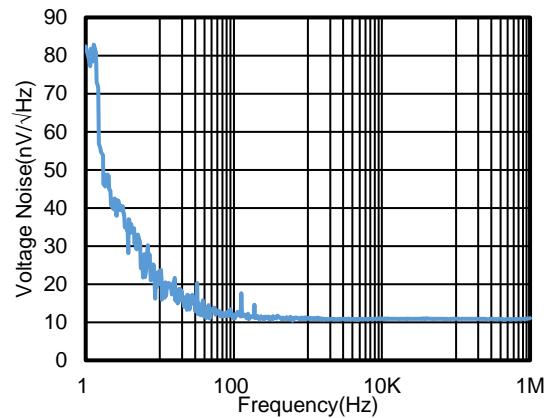

Typical Application Circuit

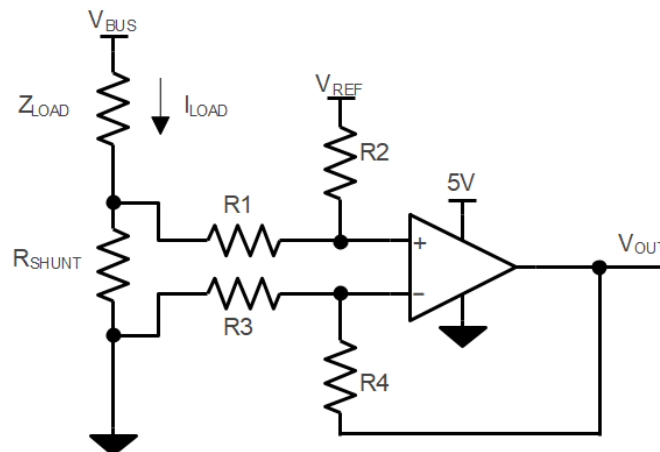

$$V_{\text{OUT}} = (I_{\text{LOAD}} \times R_{\text{SHUNT}}) \times (R_2 / R_1) + V_{\text{REF}}$$

$$\text{When } R_3 = R_1, R_2 = R_4, R_{\text{SHUNT}} \ll R_1$$

Table of Contents

Features	1
Applications	1
Description	1
Typical Application Circuit	1
Revision History	3
Pin Configuration and Functions	4
Specifications	6
Absolute Maximum Ratings ⁽¹⁾	6
ESD, Electrostatic Discharge Protection	6
Thermal Information	6
Electrical Characteristics	7
Typical Performance Characteristics.....	9
Detailed Description	13
Overview.....	13
Functional Block Diagram	13
Tape and Reel Information	14
Package Outline Dimensions	15
SOT23-5	15
SOP8	16
TSSOP8	17
MSOP8	18
Order Information	19
IMPORTANT NOTICE AND DISCLAIMER	20

Revision History

Date	Revision	Notes
2021/5/20	Rev.A.0	Initial-Release Version
2021/7/7	Rev.A.1	Updated maximum rating: Input voltage: $(-V_S) - 0.3$ to $(+V_S) + 0.3$ -> $(-V_S) - 0.3$ to 40 V
2022/4/29	Rev.A.2	Updated order information
2022/8/9	Rev.A.3	Added part number: TPA2682-TS1R

Pin Configuration and Functions

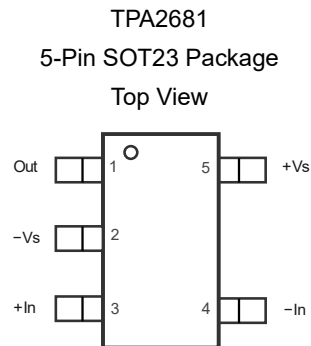
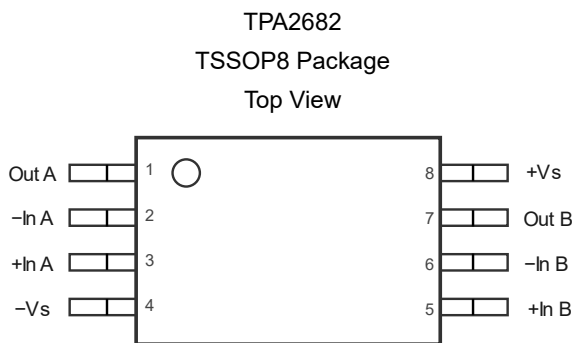
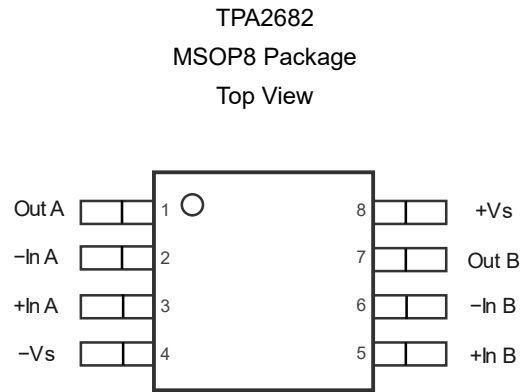
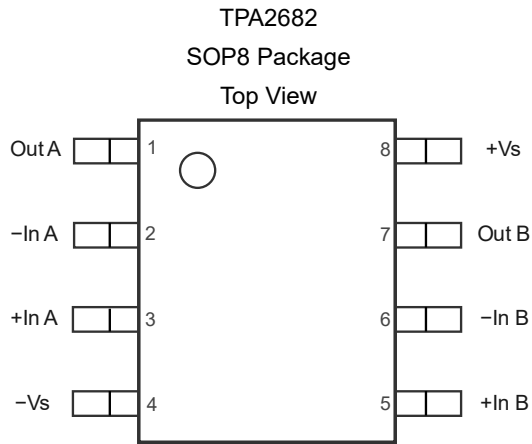

Table 6-1. Pin Functions: TPA2681

Pin	Name	I/O	Description
1	Out	Output	Output
2	-Vs		Negative power supply
3	+In	Input	Noninverting input
4	-In	Input	Inverting input
5	+Vs		Positive power supply

Table 6-2. Pin Functions: TPA2682

Pin	Name	I/O	Description
1	Out A	Output	Output
2	-In A	Input	Inverting input
3	+In A	Input	Noninverting input
4	-Vs		Negative power supply
5	+In B	Input	Noninverting input
6	-In B	Input	Inverting input
7	Out B	Output	Output
8	+Vs		Positive power supply

Specifications

Absolute Maximum Ratings⁽¹⁾

Parameter	Min	Max	Unit	
Supply Voltage: (+V _S) – (–V _S)		40	V	
Input Voltage	(–V _S) – 0.3	40	V	
Differential Input Voltage	(–V _S) – (+V _S)	(+V _S) – (–V _S)	V	
Input Current: +I _N , –I _N ⁽²⁾	–10	+10	mA	
Output Voltage	(–V _S) – 0.3	(+V _S) + 0.3	V	
Output Short-Circuit Duration ⁽³⁾		Infinite		
T _J	Maximum Junction Temperature	150	°C	
T _A	Operating Temperature Range	–40	125	°C
T _{STG}	Storage Temperature Range	–65	150	°C
T _L	Lead Temperature (Soldering 10 sec)		260	°C

(1) Stresses beyond those listed under Absolute Maximum Ratings may cause permanent damage to the device. Exposure to any Absolute Maximum Rating condition for extended periods may affect device reliability and lifetime.

(2) The inputs are protected by ESD protection diodes to the negative power supply. If the input extends more than 500 mV beyond the negative power supply, the current should be limited to less than 10 mA.

(3) A heat sink may be required to keep the junction temperature below the absolute maximum. This depends on the power supply voltage and how many comparators are shorted. Thermal resistance varies with the amount of PC board metal connected to the package. The specified values are for short traces connected to the leads.

ESD, Electrostatic Discharge Protection

Symbol	Parameter	Condition	Minimum Level	Unit
HBM	Human Body Model ESD	ANSI/ESDA/JEDEC JS-001 ⁽¹⁾	2	kV
CDM	Charged Device Model ESD	ANSI/ESDA/JEDEC JS-002 ⁽²⁾	1	kV

(1) JEDEC document JEP155 states that 500-V HBM allows safe manufacturing with a standard ESD control process.

(2) JEDEC document JEP157 states that 250-V CDM allows safe manufacturing with a standard ESD control process.

Thermal Information

Package Type	θ _{JA}	θ _{Jc}	Unit
SOT23-5	250	81	°C/W
SOP8	158	43	°C/W
MSOP8	210	45	°C/W
TSSOP8	191	50	°C/W

All test condition is $V_S = 36\text{ V}$, $T_A = 25^\circ\text{C}$, $R_L = 10\text{ k}\Omega$, unless otherwise noted.

Symbol	Parameter	Conditions	T_A	Min	Typ	Max	Unit
Power Supply							
V_S	Supply Voltage Range			8		36	V
I_Q	Quiescent Current per Amplifier	$V_S = 36\text{ V}$			6	8	mA
			-40°C to 125°C			9	mA
PSRR	Power Supply Rejection Ratio	$V_S = 8\text{ V to }36\text{ V}$		85	100		dB
			-40°C to 125°C	80			dB
Input Characteristics							
V_{OS}	Input Offset Voltage	$V_S = 36\text{ V}, V_{CM} = 2\text{ V to }34\text{ V}$		-3	0.5	3	mV
			-40°C to 125°C	-5		5	mV
		$V_S = 8\text{ V}, V_{CM} = 2\text{ V to }6\text{ V}$		-3	0.5	3	mV
			-40°C to 125°C	-5		5	mV
$V_{OS\ TC}$	Input Offset Voltage Drift		-40°C to 125°C		2		$\mu\text{V}/^\circ\text{C}$
I_B	Input Bias Current			-500	100	500	nA
			-40°C to 125°C	-800		800	nA
I_{OS}	Input Offset Current			-500	100	500	nA
			-40°C to 125°C	-800		800	nA
I_{IN}	Different Input Current	$V_S = 36\text{ V}, V_{ID} = 36\text{ V}$			10		μA
			-40°C to 125°C			100	μA
C_{IN}	Input Capacitance	Differential Mode			5		pF
		Common Mode			5		pF
A_V	Open-loop Voltage Gain	$R_{LOAD} = 10\text{ k}\Omega, V_{OUT} = 4\text{ V to }32\text{ V}$		95	105		dB
			-40°C to 125°C	90			dB
V_{CMR}	Common-mode Input Voltage Range			(V-)+2		(V+)-2	V
CMRR	Common Mode Rejection Ratio	$V_{CM} = 2\text{ V to }34\text{ V}$		100	120		dB
			-40°C to 125°C	95			dB
Output Characteristics							
	Output Swing from Positive Rail	$I_{LOAD} = 50\ \mu\text{A to }V_S/2$			1.8	2	V
			-40°C to 125°C				2.1
		$I_{LOAD} = 1\text{ mA to }V_S/2$			1.8	2.1	V
			-40°C to 125°C				2.2
		$I_{LOAD} = 5\text{ mA to }V_S/2$			2	2.2	V
			-40°C to 125°C				2.35

Electrical Characteristics (Continued)

Symbol	Parameter	Conditions	T _A	Min	Typ	Max	Unit
	Output Swing from Negative Rail	I _{LOAD} = 50 μA to V _S /2			0.75	1	V
			-40°C to 125°C			1.15	V
		I _{LOAD} = 1 mA to V _S /2			1	1.2	V
			-40°C to 125°C			1.3	V
		I _{LOAD} = 5 mA to V _S /2			1.3	1.5	V
			-40°C to 125°C			1.6	V
I _{SC}	Output Short-Circuit Current	Source			100		mA
			-40°C to 85°C				mA
			-40°C to 125°C				mA
		Sink			60		mA
			-40°C to 85°C				mA
			-40°C to 125°C				mA
AC Specifications							
GBW	Gain-Bandwidth Product				20		MHz
SR	Slew Rate				10		V/μs
			-40°C to 125°C			8	
t _{OR}	Overload Recovery				350		ns
t _S	Settling Time, 0.1%	G = 1, 10 V step			1		μs
	Settling Time, 0.01%				1.1		μs
PM	Phase Margin	R _L =10 K, C _L =50 pF			55		°
GM	Gain Margin	R _L =10 K, C _L =50 pF			11		dB
Noise Performance							
E _N	Input Voltage Noise	f = 0.1 Hz to 10 Hz			0.8		μV _{PP}
e _N	Input Voltage Noise Density	f = 1 Hz			80		nV/√Hz
		f = 1 kHz			10		nV/√Hz
		f = 10 kHz			10		nV/√Hz
		f = 100 kHz			10		nV/√Hz
i _N	Input Current Noise	f = 10 kHz			2		pA/√Hz
THD+N	Total Harmonic Distortion and Noise	f = 1 kHz, G = 1, R _L = 10 kΩ, V _{OUT} = 1V _{RMS}			0.0005		%

$V_s = \pm 15\text{ V}$, $V_{CM} = 0\text{ V}$, $R_L = 10\text{ k}\Omega$, unless otherwise specified.

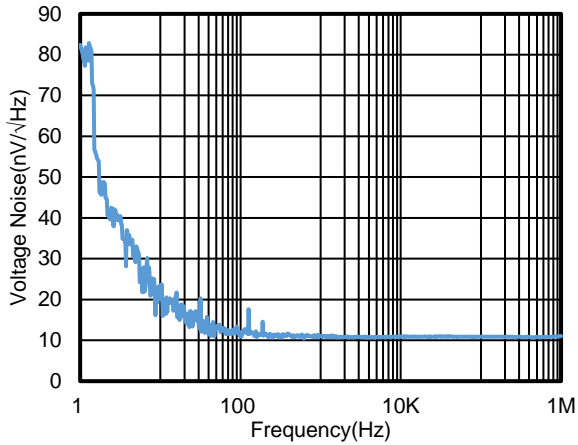

Figure 1. Voltage Noise Density vs. Frequency

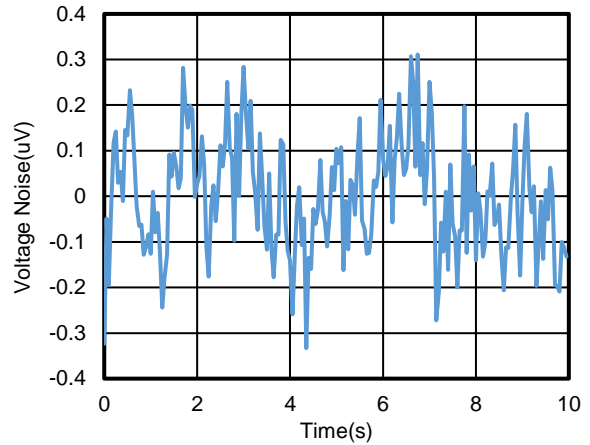

Figure 2. 0.1 to 10 Hz Voltage Noise

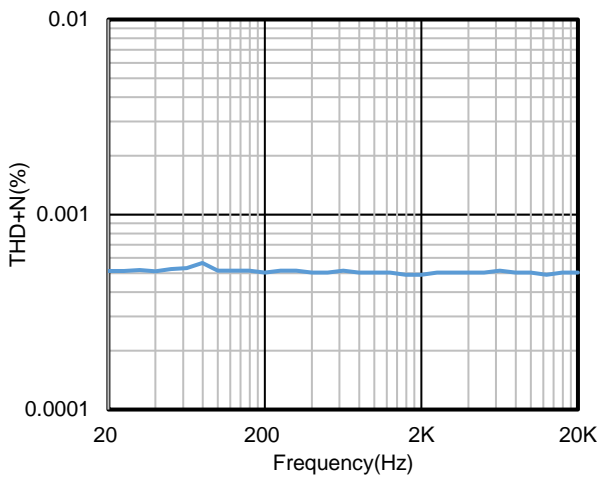

Figure 3. THD+N = 0.0005%, G = 1, $V_s = 30\text{ V}$

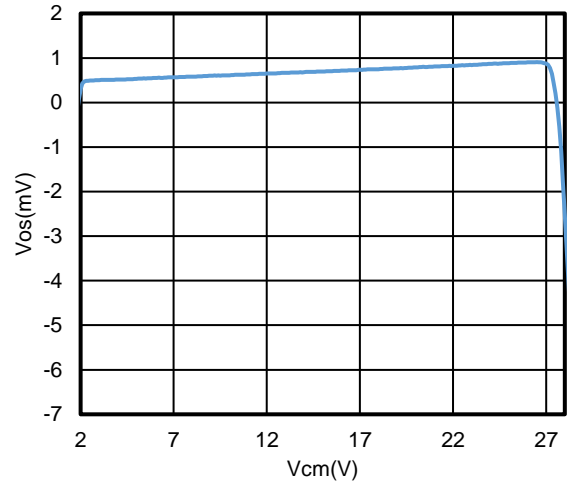

Figure 4. V_{os} vs. Common-Mode Voltage, $V_s = 30\text{ V}$

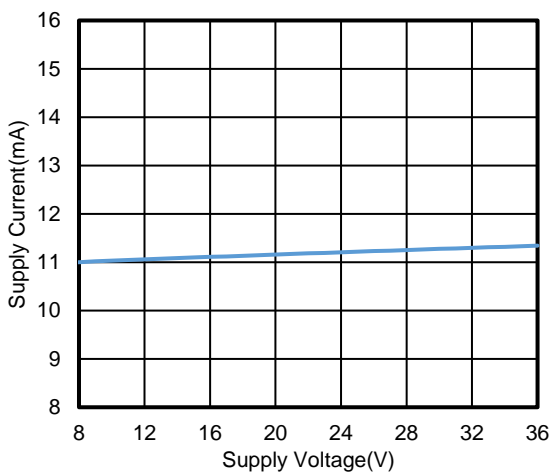

Figure 5. I_q vs. Supply Voltage

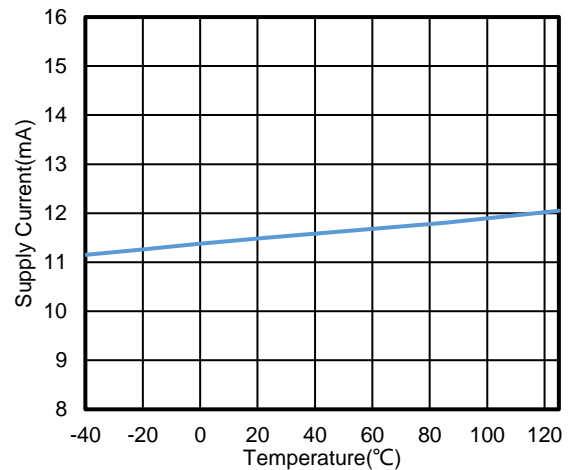

Figure 6. I_q vs. Temperature, +15 V Supply, TPA2682

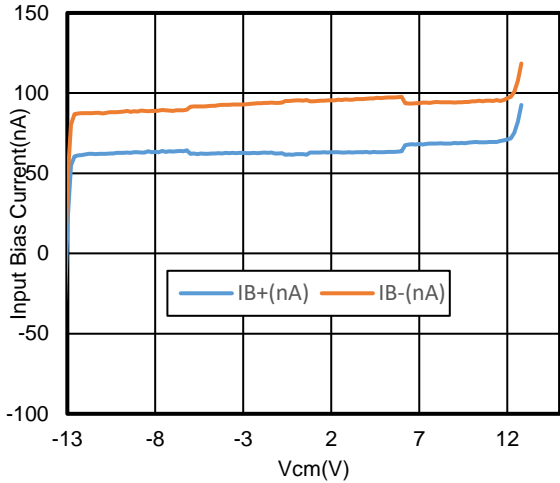

Figure 7. I_B vs. Common-Mode Voltage, $V_S = +15\text{ V}, -15\text{ V}$

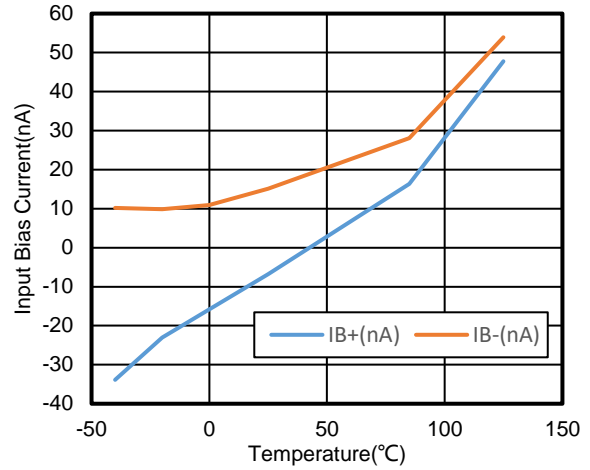

Figure 8. I_B and I_{OS} vs. Temperature

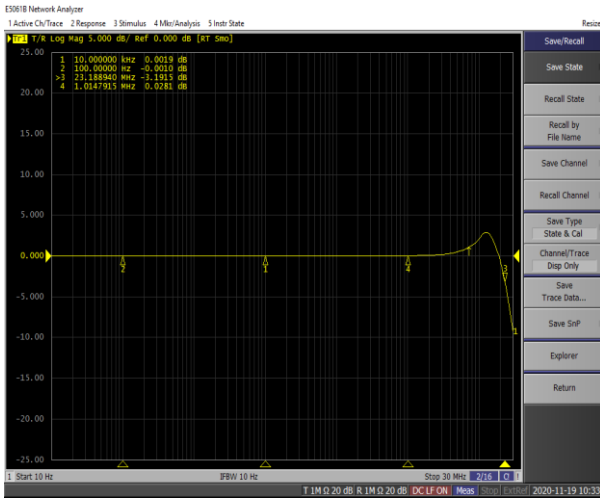

Figure 9. -3 dB Bandwidth, $G = 1, V_S = 30\text{ V}$

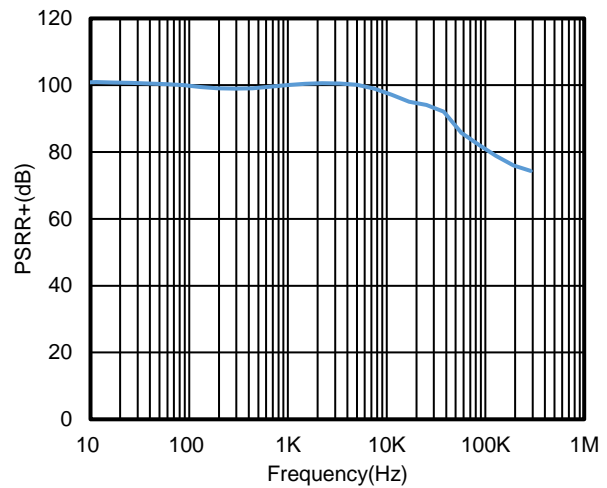

Figure 10. PSRR+ vs. Frequency

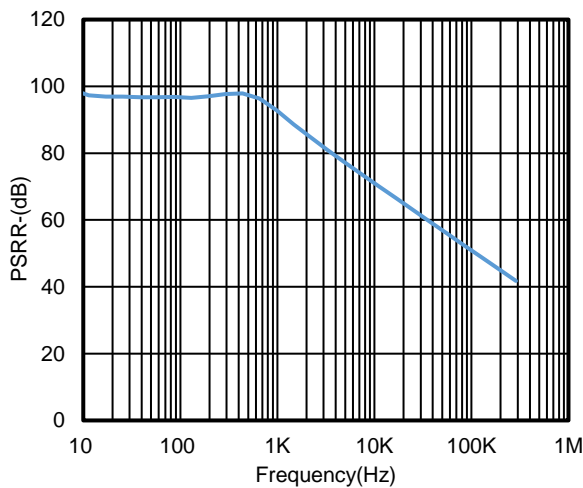

Figure 11. PSRR- vs. Frequency

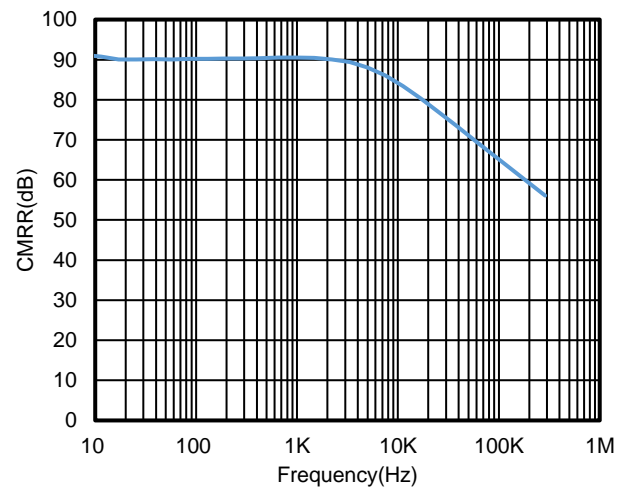

Figure 12. CMRR vs. Frequency



Time: 1μs/div, Measure Time: 310 ns, G=10

Figure 13. Positive Overload Recovery



Time: 1μs/div, Measure Time: 350 ns, G=10

Figure 14. Negative Overload Recovery

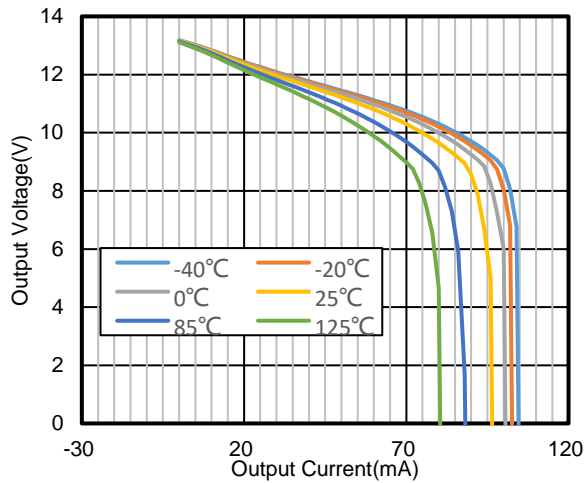

Figure 15. V_{OUT} vs. I_{OUT} , Source

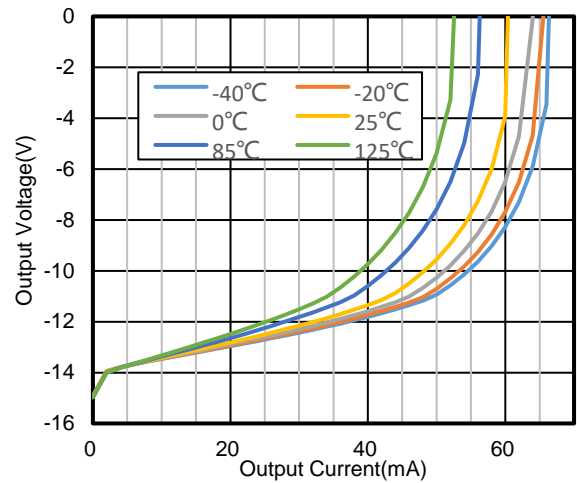

Figure 16. V_{OUT} vs. I_{OUT} , Sink

Power On and Off Behavior, 36 V Single Supply, $G = 1$, Input = $V_s / 2$, Yellow: Output, Green: V_s



Figure 17. 1 ms, 0 V to 36 V Power on and off Time



Figure 18. 1 ms, 3 V to 36 V Power on and off Time



Figure 19. 10 ms, 0 V to 36 V Power on and off Time



Figure 20. 10 ms, 3 V to 36 V Power on and off Time



Figure 21. 100 ms, 0 V to 36 V Power on and off Time



Figure 22. 100 ms, 3 V to 36 V Power on and off Time

Detailed Description

Overview

The TPA268X series is a new family of high voltage op amplifiers. These devices operate from 8 V to 36 V, are unity-gain stable, and are designed for a wide range of general-purpose applications.

Functional Block Diagram

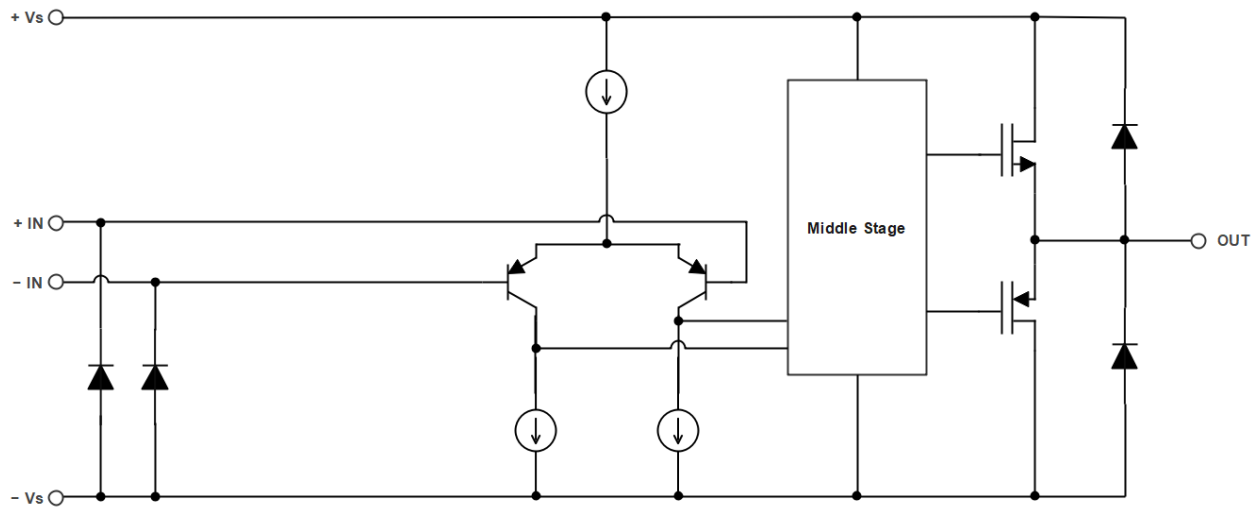
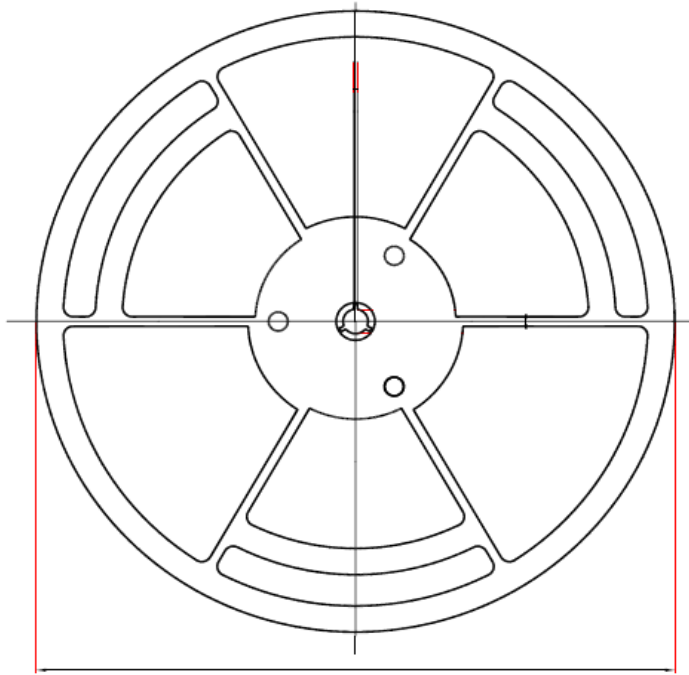
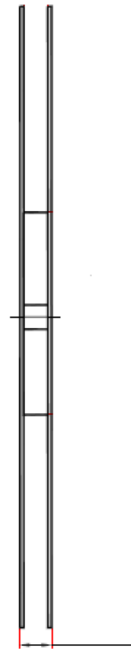

Figure 23. Functional Block Diagram

Tape and Reel Information



D1: Reel Diameter



W1: Reel Width

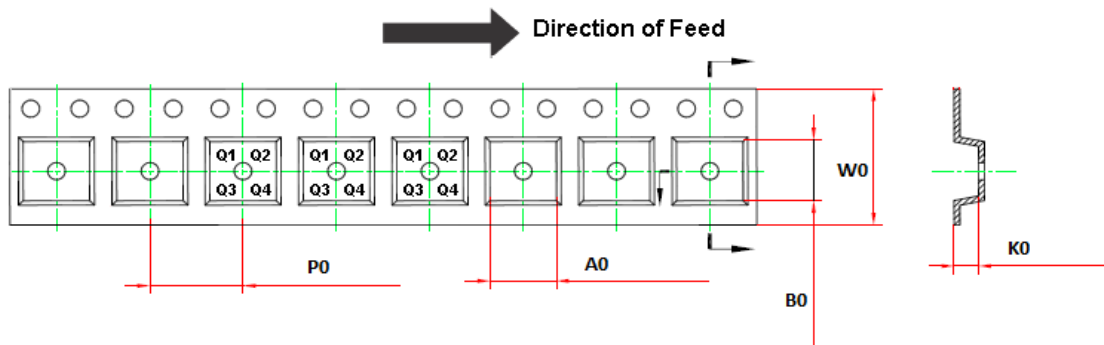

Order Number	Package	D1 (mm)	W1 (mm)	A0 (mm)	B0 (mm)	K0 (mm)	P0 (mm)	W0 (mm)	Pin1 Quadrant
TPA2681-S5TR	SOT23-5	180.0	13.1	3.2	3.2	1.4	4.0	8.0	Q3
TPA2682-SO1R	SOP8	330.0	17.6	6.4	5.4	2.1	8.0	12.0	Q1
TPA2682-VS1R	MSOP8	330.0	17.6	5.2	3.3	1.5	8.0	12.0	Q1
TPA2682-TS1R	TSSOP8	330.0	17.6	6.8	3.3	1.2	8.0	12.0	Q1

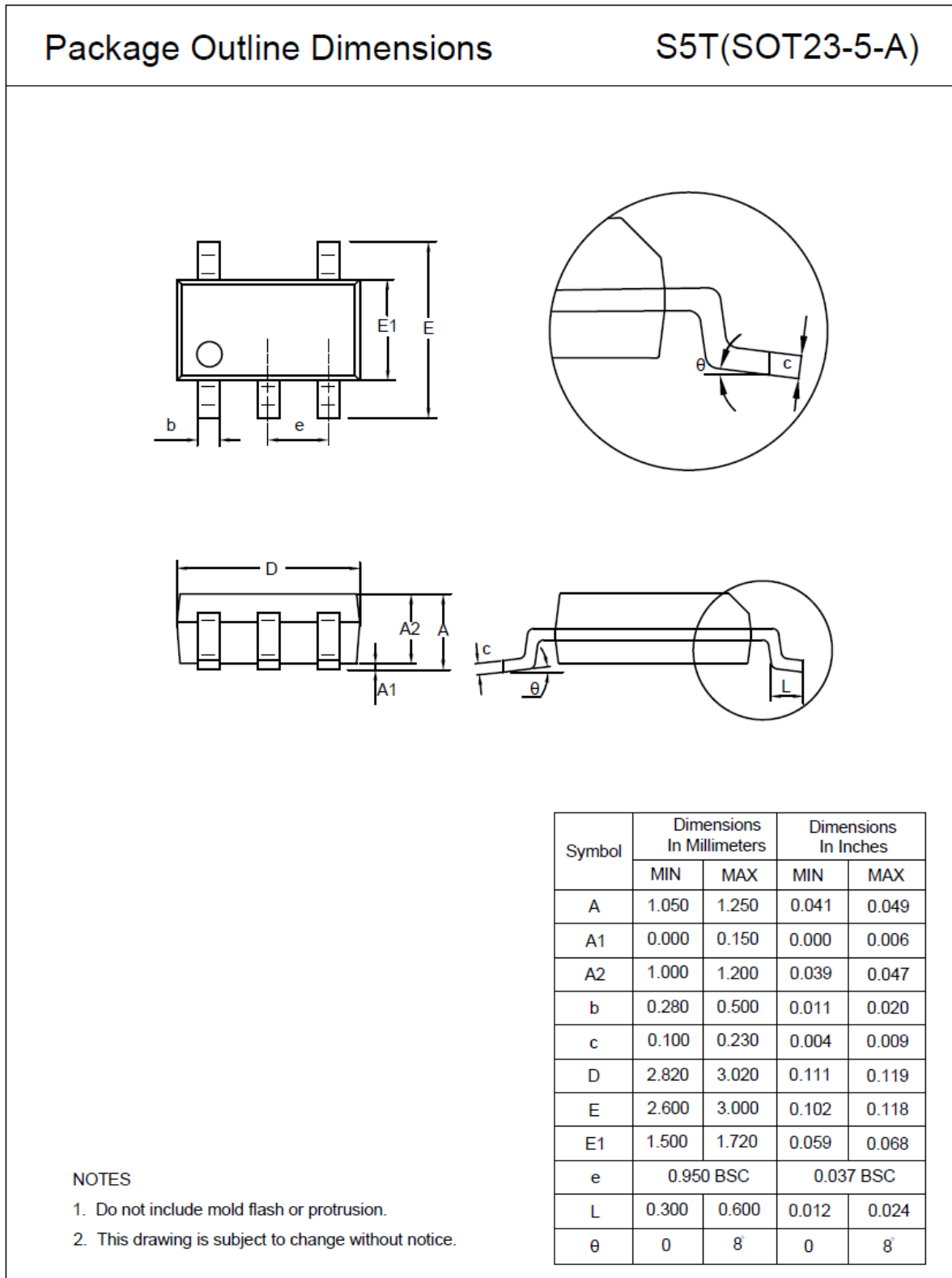
Package Outline Dimensions
SOT23-5

SOP8

Package Outline Dimensions

SO1(SOP-8-A)

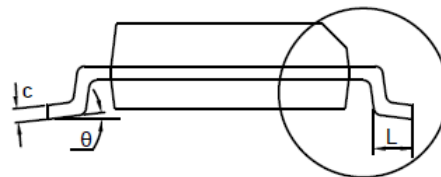
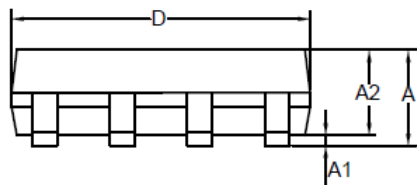
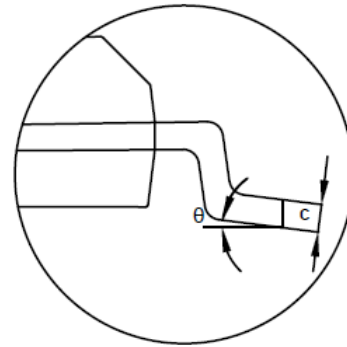
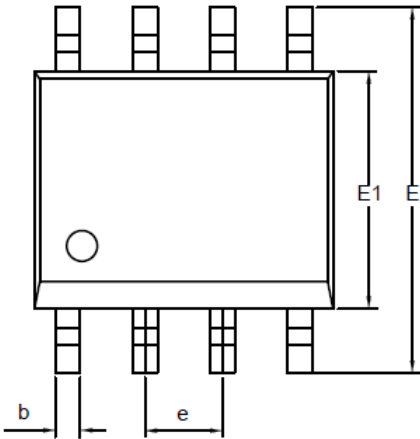

Symbol	Dimensions In Millimeters		Dimensions In Inches	
	MIN	MAX	MIN	MAX
A	1.350	1.750	0.053	0.069
A1	0.050	0.250	0.002	0.010
A2	1.250	1.550	0.049	0.061
b	0.330	0.510	0.013	0.020
c	0.170	0.250	0.007	0.010
D	4.700	5.100	0.185	0.201
E	5.800	6.200	0.228	0.244
E1	3.800	4.000	0.150	0.157
e	1.270 BSC		0.050 BSC	
L	0.400	1.000	0.016	0.039
theta	0	8	0	8

NOTES

1. Do not include mold flash or protrusion.
2. This drawing is subject to change without notice.

TSSOP8

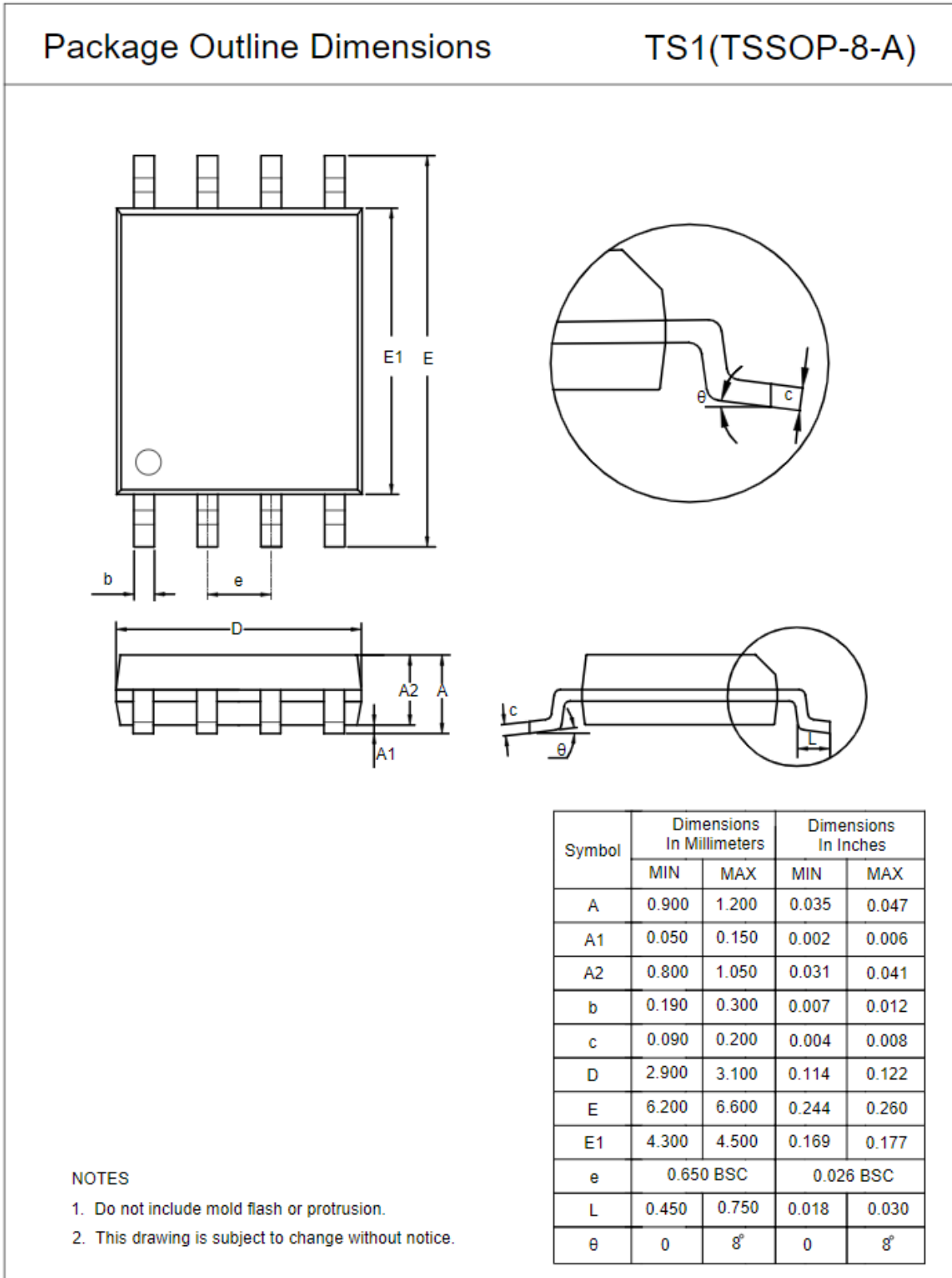

MSOP8

Package Outline Dimensions

VS1(MSOP-8-A)

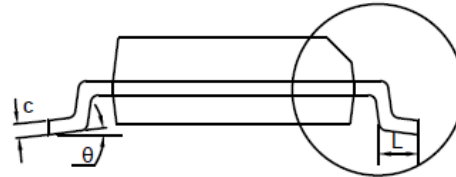
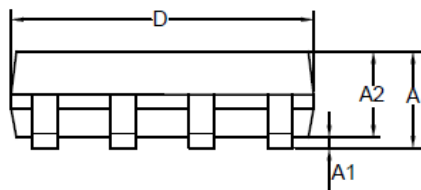
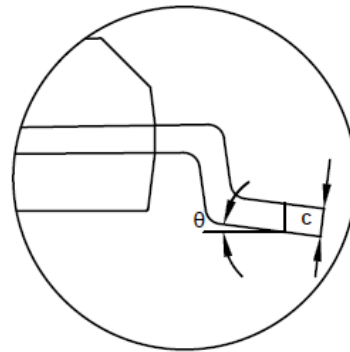
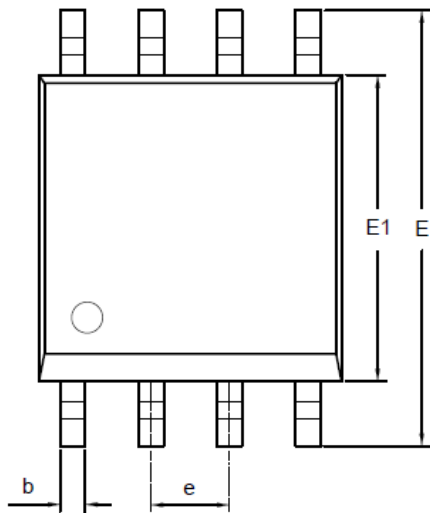

Symbol	Dimensions In Millimeters		Dimensions In Inches	
	MIN	MAX	MIN	MAX
A	0.800	1.100	0.031	0.043
A1	0.050	0.150	0.002	0.006
A2	0.750	0.950	0.030	0.037
b	0.250	0.380	0.010	0.015
c	0.090	0.230	0.004	0.009
D	2.900	3.100	0.114	0.122
E	4.700	5.100	0.185	0.201
E1	2.900	3.100	0.114	0.122
e	0.650 BSC		0.026 BSC	
L	0.400	0.800	0.016	0.031
θ	0	8°	0	8°

NOTES

1. Do not include mold flash or protrusion.
2. This drawing is subject to change without notice.

Order Information

Order Number	Operating Temperature Range	Package	Marking Information	MSL	Transport Media, Quantity	Eco Plan
TPA2681-S5TR	-40 to 125°C	SOT23-5	268	3	Tape and Reel, 3,000	Green
TPA2682-SO1R	-40 to 125°C	SOP8	A2682	3	Tape and Reel, 4,000	Green
TPA2682-VS1R	-40 to 125°C	MSOP8	A2682	3	Tape and Reel, 3,000	Green
TPA2682-TS1R	-40 to 125°C	TSSOP8	A2682	3	Tape and Reel, 3,000	Green

Green: 3PEAK defines "Green" to mean RoHS compatible and free of halogen substances.

IMPORTANT NOTICE AND DISCLAIMER

Copyright© 3PEAK 2012-2023. All rights reserved.

Trademarks. Any of the 思瑞浦 or 3PEAK trade names, trademarks, graphic marks, and domain names contained in this document /material are the property of 3PEAK. You may NOT reproduce, modify, publish, transmit or distribute any Trademark without the prior written consent of 3PEAK.

Performance Information. Performance tests or performance range contained in this document/material are either results of design simulation or actual tests conducted under designated testing environment. Any variation in testing environment or simulation environment, including but not limited to testing method, testing process or testing temperature, may affect actual performance of the product.

Disclaimer. 3PEAK provides technical and reliability data (including data sheets), design resources (including reference designs), application or other design recommendations, networking tools, security information and other resources "As Is". 3PEAK makes no warranty as to the absence of defects, and makes no warranties of any kind, express or implied, including without limitation, implied warranties as to merchantability, fitness for a particular purpose or non-infringement of any third-party's intellectual property rights. Unless otherwise specified in writing, products supplied by 3PEAK are not designed to be used in any life-threatening scenarios, including critical medical applications, automotive safety-critical systems, aviation, aerospace, or any situations where failure could result in bodily harm, loss of life, or significant property damage. 3PEAK disclaims all liability for any such unauthorized use.