

Features

- Supply Voltage: 2.5V to 6.0V
- Low Supply Current: typical 600µA per channel
- Rail to Rail Input and Output
- Bandwidth: typical 6 MHz
- Slew Rate: typical 4.5V/µs
- Excellent EMI Suppress Performance
- Offset Voltage: maximum ±3mV
- Offset Voltage Temperature Drift: typical 1 µV/°C
- Low Noise: typical 19 nV/√Hz at 1kHz
- High Output Capability: typical 100mA
- -40°C to 125°C Operation Temperature Range
- Green, Popular Type Package

Applications

- White Goods
- Motor Control

Description

The TP156XAL1 series are CMOS dual, and quad RRIO op-amps with low offset, low power and stable high frequency response. They incorporate 3PEAK's proprietary and patented design techniques to achieve very good AC performance with 6MHz bandwidth, 4.5V/µs slew rate and low distortion while drawing only 600µA of quiescent current per amplifier. The input common-mode voltage range extends 300mV beyond V₋ and V₊, and the outputs swing rail-to-rail. The TP156XAL1 family can be used as plug-in replacements for many commercially available op-amps to reduce power and improve input/output range and performance.

The combination of features makes the TP156XAL1 ideal choices for motor control and portable audio amplification, sound ports, and other consumer Audio. The TP156XAL1 Op-amp is very stable, and it is capable of driving heavy capacitive loads such as those found in LCDs. The ability to swing rail-to-rail at the inputs and outputs enables designers to buffer CMOS DACs, ASICs, or other wide output swing devices in single-supply systems.

Pin Configuration

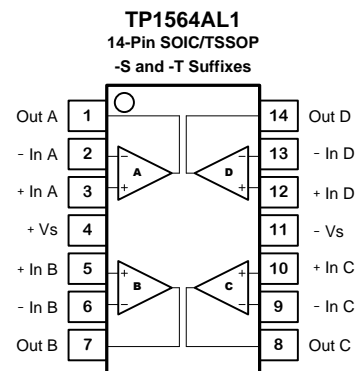
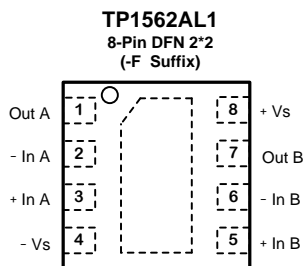
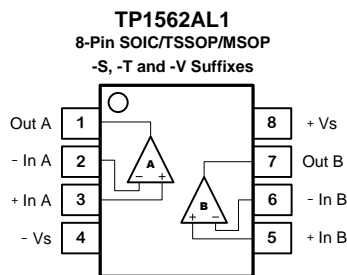
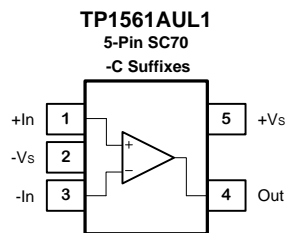
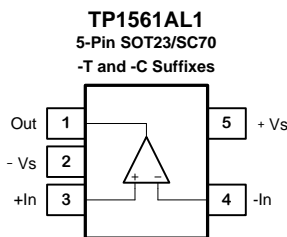

The thermal pad of DFN package is recommended to be left float or connected to -Vs

Table of Contents

| | |
|---------------------------------------------------------|-----------|
| Features | 1 |
| Applications | 1 |
| Description | 1 |
| Pin Configuration | 1 |
| Table of Contents | 2 |
| Revision History | 3 |
| Order Information | 4 |
| Absolute Maximum Ratings ^{Note 1} | 5 |
| ESD Rating | 5 |
| Thermal Information | 5 |
| Electrical Characteristics | 6 |
| Typical Performance Characteristics | 8 |
| Application Information | 11 |
| Low Supply Voltage and Low Power Consumption | 11 |
| Ground Sensing and Rail to Rail Output | 11 |
| Driving Large Capacitive Load | 11 |
| Tape and Reel Information | 12 |
| Package Outline Dimensions | 13 |
| SOT353 (SC70-5) | 13 |
| SOT23-5 | 14 |
| SOP8 | 15 |
| TSSOP8 | 16 |
| MSOP8 | 17 |
| DFN2X2-8 | 18 |
| SOP14 | 19 |
| TSSOP14 | 20 |
| IMPORTANT NOTICE AND DISCLAIMER | 21 |

Revision History

| Date | Revision | Notes |
|------------|----------|-----------------------------------------------------------------------------------------------------------------------------------------------------------------------------------------------------------------------------------------------------------------------------------|
| 2017/3/1 | Rev.Pre | Pre-Release Version |
| 2017/7/5 | Rev.0 | Release Version, confirm spec limit |
| 2017/10/28 | Rev.0.01 | TP1564AL1-TR sample is ready. TP1562AL1-VR(MSL1) sample is ready. Correct the max of Common-mode Input Voltage Range in Electrical Characteristics from (V+) - 0.1 to (V+) + 0.1. Correct Operating Temperature Range in Maximum Ratings from -45 to 125°C to -40 to 125°C. |
| 2017/12/26 | Rev.0.02 | Correct mark information of TP1562AL1-VR: XXXX change to XXXXL |
| 2018/5/30 | Rev.0.03 | Updated ESD condition to JS001/002 |
| 2018/8/30 | Rev.A | Updated full temperature spec, update Vos spec at 5V Vcm |
| 2019/2/25 | Rev.A01 | Added New Part: TP1562AL1-FR Added Spec: Ib: min and max at 25°C and 125°C; open loop SR: min at 25°C, 85°C and 125°C Updated Package Outline Dimensions to newest factory data. |
| 2020/5/26 | Rev.A.2 | Updated MSL of TP1564AL1-TR: MSL1 -> MSL 3 |
| 2021/11/15 | Rev.A.3 | Added New Part: TP1561AUL1-CR |
| 2021/11/18 | Rev.A.4 | Update MSL Level of TP1561AUL1-CR: "Pending" -> "3" |
| 2022/4/21 | Rev.A.5 | Updated Package Outline Dimensions of DFN-8 2*2. |
| 2023/5/23 | Rev.A.6 | The following updates are all about the new datasheet formats or typo, the actual product remains unchanged. Updated to new format of package dimensions and tape and reel information. Added typical value of Vos. Updated address of web site. |
| 2024/2/4 | Rev.A.7 | Added minimal value of SR with condition of "A _V = 1, V _{OUT} = 1.5V to 3.5V, C _{LOAD} = 60pF, R _{LOAD} = 1k Ω ". |

Order Information

| Order Number | Operating Temperature Range | Package | Marking Information | MSL | Transport Media, Quantity |
|--------------------------------|-----------------------------|-----------------|---------------------|-----|---------------------------|
| TP1561AL1-TR | -40 to 125°C | SOT23-5 | 61LXX | 1 | Tape and Reel, 3000 |
| TP1561AL1-CR ^{Note 1} | -40 to 125°C | SOT353 (SC70-5) | 61LXX | 1 | Tape and Reel, 3000 |
| TP1561AUL1-CR | -40 to 125°C | SOT353 (SC70-5) | 61UXX | 3 | Tape and Reel, 3000 |
| TP1562AL1-SR | -40 to 125°C | SOP8 | 1562A XXXXL | 1 | Tape and Reel, 4000 |
| TP1562AL1-TSR | -40 to 125°C | TSSOP8 | 1562A XXXXL | 1 | Tape and Reel, 3000 |
| TP1562AL1-VR | -40 to 125°C | MSOP8 | 1562A XXXXL | 1 | Tape and Reel, 3000 |
| TP1562AL1-FR | -40 to 125°C | DFN2X2-8 | 562 XXXXL | 1 | Tape and Reel, 3000 |
| TP1564AL1-SR | -40 to 125°C | SOP14 | 1564A XXXXL | 1 | Tape and Reel, 2500 |
| TP1564AL1-TR | -40 to 125°C | TSSOP14 | 1564A XXXXL | 3 | Tape and Reel, 3000 |

Note 1: The part will be in mass production in 3 months after manufacture start.

Absolute Maximum Ratings ^{Note 1}

| Parameters | Rating |
|--------------------------------------------------------|------------------------------------------------------------------------------------|
| Supply Voltage, (+V _S)– (-V _S) | 7 V |
| Voltage on Input/ Output Pin | (-V _S) – 0.3 to (+V _S) + 0.3 |
| Differential Input Voltage | (-V _S) – (+V _S) to (+V _S) – (-V _S) |
| Input Current: +IN, –IN ^{Note 2} | ±10mA |
| Output Short-Circuit Duration ^{Note 3} | Infinite |
| Maximum Junction Temperature | 150°C |
| Operating Temperature Range | –40 to 125°C |
| Storage Temperature Range | –65 to 150°C |
| Lead Temperature (Soldering, 10 sec) | 260°C |

Note 1: Stresses beyond those listed under Absolute Maximum Ratings may cause permanent damage to the device. Exposure to any Absolute Maximum Rating condition for extended periods may affect device reliability and lifetime.

Note 2: The inputs are protected by ESD protection diodes to each power supply. If the input extends more than 300mV beyond the power supply, the input current should be limited to less than 10mA.

Note 3: A heat sink may be required to keep the junction temperature below the absolute maximum. This depends on the power supply voltage and how many amplifiers are shorted. Thermal resistance varies with the amount of PC board metal connected to the package. The specified values are for short traces connected to the leads.

ESD Rating

| Symbol | Parameter | Condition | Minimum Level | Unit |
|--------|--------------------------|----------------------------------------------------------|---------------|------|
| HBM | Human Body Model ESD | ANSI/ESDA/JEDEC JS-001, TP1561AUL1-CR | 6 | kV |
| | | ANSI/ESDA/JEDEC JS-001, All product except TP1561AUL1-CR | 8 | kV |
| CDM | Charged Device Model ESD | ANSI/ESDA/JEDEC JS-002 | 2 | kV |

Thermal Information

| Package Type | θ _{JA} | θ _{JC} | Unit |
|---------------|-----------------|-----------------|------|
| 5-Pin SC70 | 400 | 210 | °C/W |
| 5-Pin SOT23 | 250 | 81 | °C/W |
| 8-Pin SOIC | 158 | 43 | °C/W |
| 8-Pin TSSOP | 191 | 44 | °C/W |
| 8-Pin MSOP | 210 | 45 | °C/W |
| 8-Pin DFN 2*2 | 100 | 60 | °C/W |
| 14-Pin SOIC | 120 | 36 | °C/W |
| 14-Pin TSSOP | 180 | 35 | °C/W |

Electrical Characteristics

All test condition is $V_S = 5V$, $T_A = 25^\circ C$, $R_L = 2k\Omega$, $C_L = 100pF$, unless otherwise noted.

| Symbol | Parameter | Conditions | Min | Typ | Max | Unit |
|-------------------------------|---------------------------------|------------------------------------------------------------------------------------|------------|-----------|------------|------------------|
| Power Supply | | | | | | |
| V_S | Supply Voltage Range | | 2.5 | | 6 | V |
| I_Q | Quiescent Current per Amplifier | | | 600 | 900 | μA |
| | | $T_A = -40$ to $125^\circ C$ | | | 1000 | μA |
| PSRR | Power Supply Rejection Ratio | | 75 | 90 | | dB |
| Input Characteristics | | | | | | |
| V_{OS} | Input Offset Voltage | $V_{CM} = 0V$ to $3V$ | -3 | ± 1 | 3 | mV |
| V_{OS} | Input Offset Voltage | $V_{CM} = 0V$ to $3V$, $T_A = -40$ to $125^\circ C$ | -4 | | 4 | mV |
| $V_{OS\ TC}$ | Input Offset Voltage Drift | $T_A = -40$ to $125^\circ C$ | | 1 | | $\mu V/^\circ C$ |
| I_B | Input Bias Current | $T_A = 25^\circ C$ | -200 | 1 | 200 | μA |
| | | $T_A = 125^\circ C$ | -500 | 25 | 500 | μA |
| I_{OS} | Input Offset Current | | | 1 | | μA |
| R_{IN} | Input Impedence | | | 10^{12} | | Ω |
| C_{IN} | Input Capacitance | Differential Mode | | 8 | | pF |
| | | Common Mode | | 7 | | pF |
| A_v | Open-loop Voltage Gain | $R_{LOAD} = 10k\Omega$ | 80 | 100 | | dB |
| V_{CMR} | Common-mode Input Voltage Range | | (V-) - 0.1 | | (V+) + 0.1 | V |
| CMRR | Common Mode Rejection Ratio | $V_{CM} = 0V$ to $2.5V$ | 70 | 100 | | dB |
| Xtalk | Channel Separation | $f = 1kHz$, $R_L = 2k\Omega$ | | 110 | | dB |
| Output Characteristics | | | | | | |
| V_{OH}, V_{OL} | Maximum Output Voltage Swing | $R_{LOAD} = 10k\Omega$ | | 3 | 15 | mV |
| | | $R_{LOAD} = 10k\Omega$, $T_A = -40$ to $125^\circ C$ | | | 20 | mV |
| I_{SC} | Output Short-Circuit Current | | 90 | 100 | | mA |
| | | $T_A = -40$ to $85^\circ C$ | 75 | | | mA |
| | | $T_A = -40$ to $125^\circ C$ | 65 | | | mA |
| AC Specifications | | | | | | |
| GBW | Gain-Bandwidth Product | | | 6 | | MHz |
| SR | Slew Rate ⁽¹⁾ | $A_v = 1$, $V_{OUT} = 1.5V$ to $3.5V$, $C_{LOAD} = 60pF$, $R_{LOAD} = 1k\Omega$ | 3 | 4.5 | | V/ μs |
| SR | Slew Rate, Open Loop | Open Loop | 3 | 4.5 | | V/ μs |
| | | Open Loop, $T_A = -40$ to $85^\circ C$ | 2.3 | | | V/ μs |
| | | Open Loop, $T_A = -40$ to $125^\circ C$ | 2 | | | V/ μs |
| t_s | Settling Time, 0.1% | $A_v = 1$, 2V Step, $C_{LOAD} = 60pF$, $R_{LOAD} = 1k\Omega$ | | 0.8 | | μs |
| | Settling Time, 0.01% | | | 1 | | μs |
| PM | Phase Margin | $R_{LOAD} = 1k\Omega$, $C_{LOAD} = 60pF$ | | 60 | | $^\circ$ |
| GM | Gain Margin | $R_{LOAD} = 1k\Omega$, $C_{LOAD} = 60pF$ | | 15 | | dB |

| Noise Performance | | | | | | |
|-------------------|-------------------------------------|-----------------------------------------------------|--|-------|--|-----------------------|
| E_N | Input Voltage Noise | f = 0.1Hz to 10Hz | | 8 | | μ V _{PP} |
| e_N | Input Voltage Noise Density | f = 1kHz | | 19 | | nV/ \sqrt Hz |
| i_N | Input Current Noise | f = 1kHz | | 2 | | fA/ \sqrt Hz |
| THD+N | Total Harmonic Distortion and Noise | f = 1kHz, AV = 1, RL = 2k Ω , VOU = 1Vp-p | | 0.003 | | % |

(1) Provided by bench test and design simulation.

Typical Performance Characteristics

V_s = 5V, V_{CM} = 2.5V, R_L = Open, unless otherwise specified.

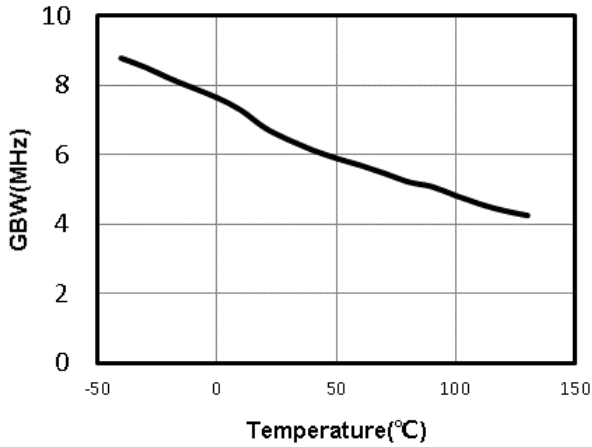

Figure 1. Unity Gain Bandwidth vs. Temperature

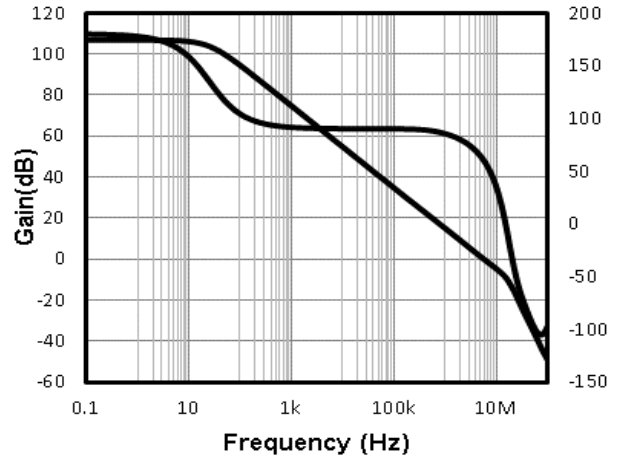

Figure 2. Open-Loop Gain and Phase

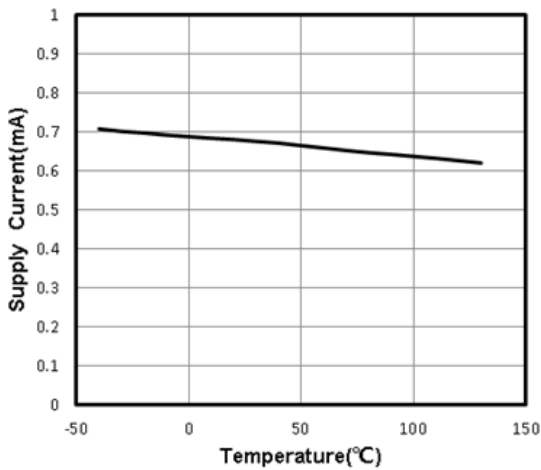

Figure 3. Supply Current vs. Temperature

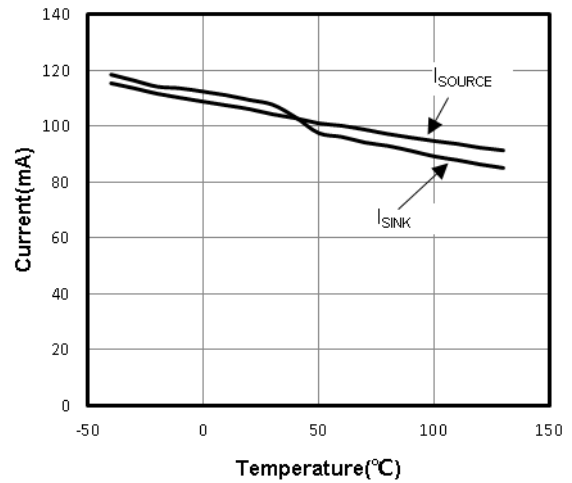

Figure 4. Short Circuit Current vs. Temperature

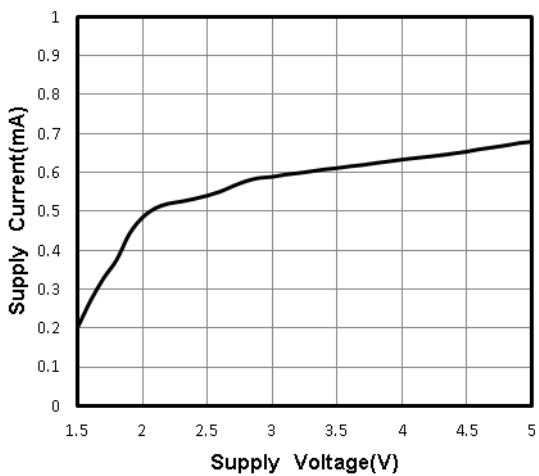

Figure 5. Quiescent Current vs. Supply Voltage

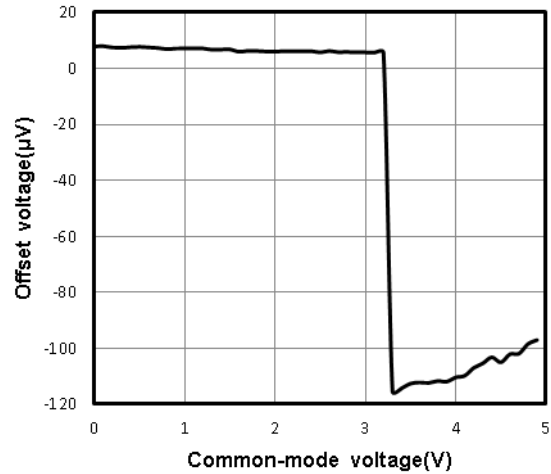

Figure 6. Offset Voltage vs. Common-Mode Voltage

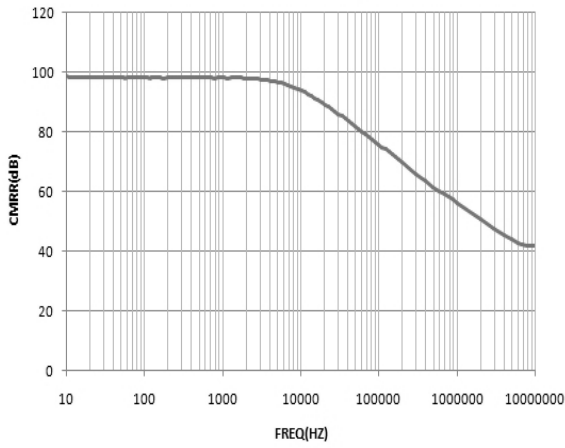

Figure 7. CMRR vs. Frequency

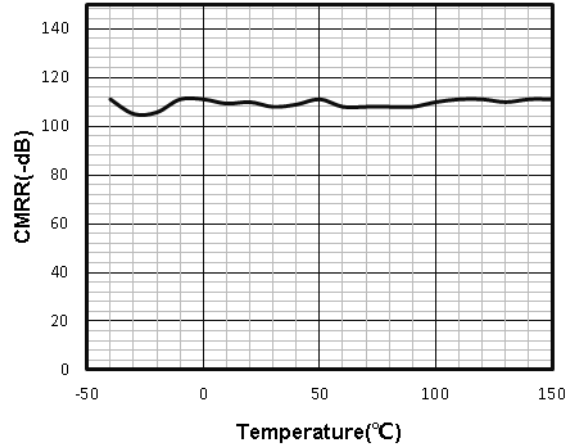

Figure 8. CMRR vs. Temperature

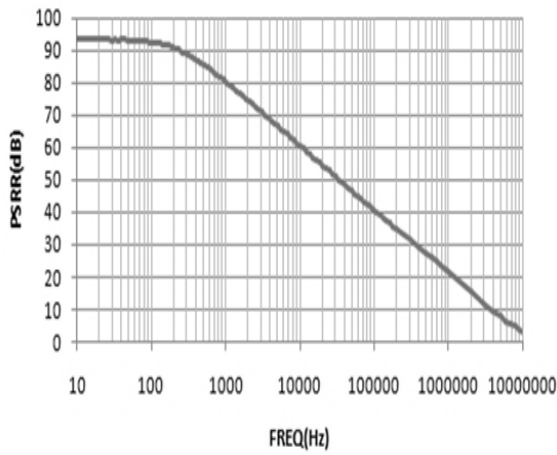

Figure 9. PSRR vs. Frequency

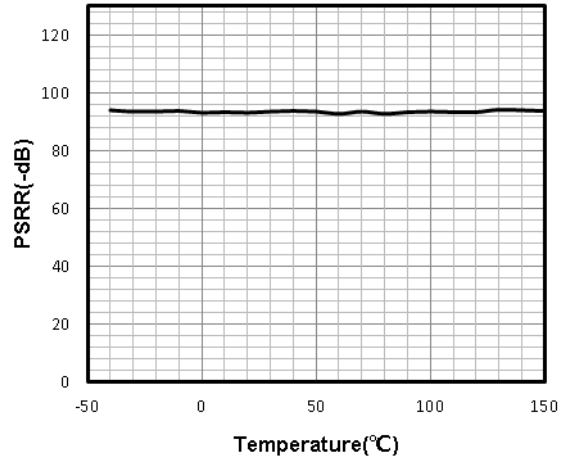

Figure 10. PSRR vs. Temperature

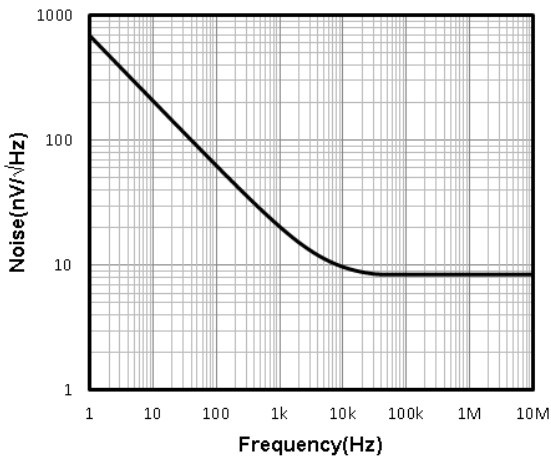

Figure 11. Input Voltage Noise Spectral Density

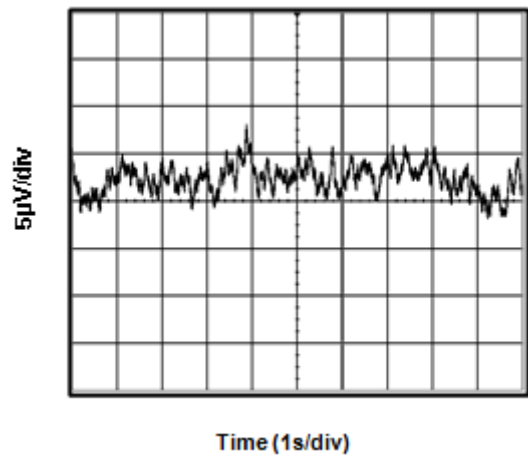

Figure 12. 0.1 Hz to 10 Hz Input Voltage Noise

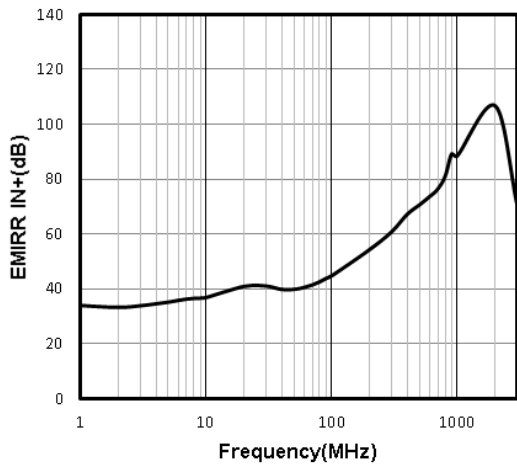
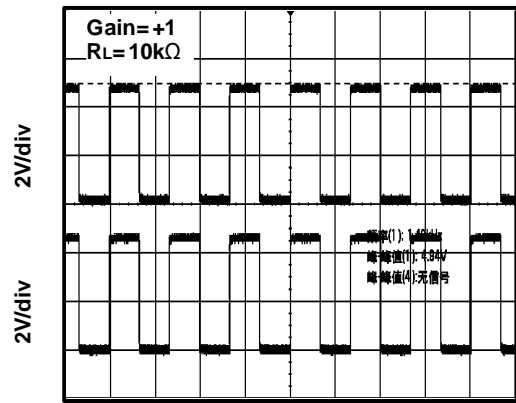
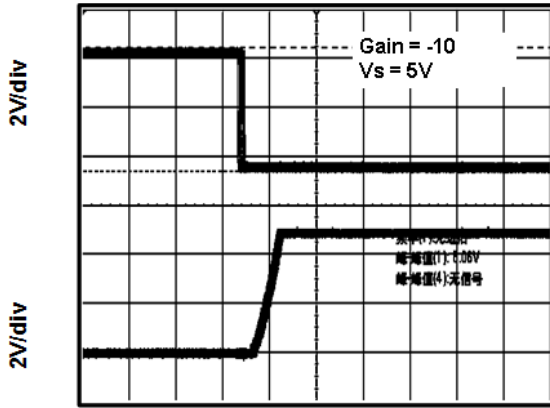

Figure 13. EMIRR IN+ vs. Frequency



Time (500 μ s/div)

Figure 14. Large-Scale Step Response



Time (2 μ s/div)

Figure 15. Negative Over-Voltage Recovery

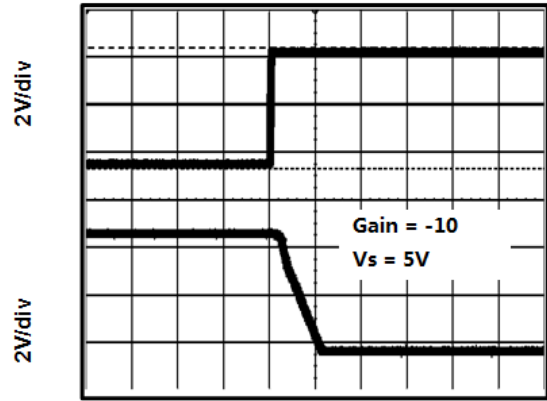

Time (1 μ s/div)

Figure 16. Positive Over-Voltage Recovery

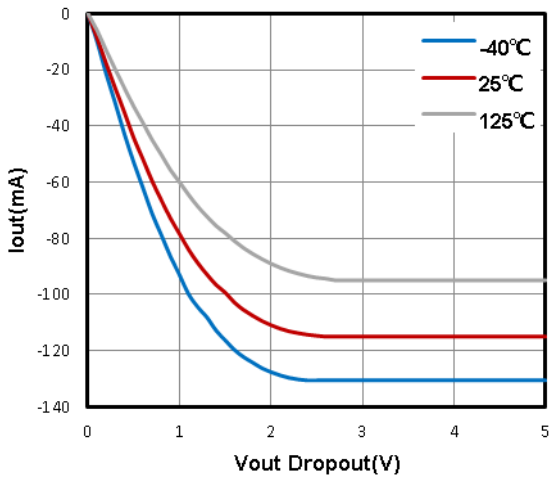

Figure 17. Negative Output Swing vs. Load Current

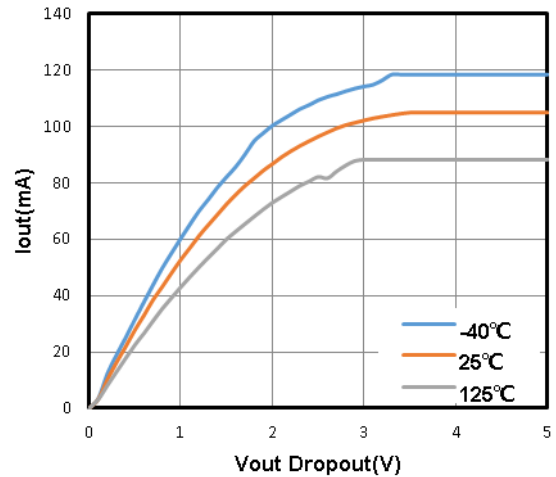

Figure 18. Positive Output Swing vs. Load Current

Application Information

Low Supply Voltage and Low Power Consumption

The TP156XAL1 family of operational amplifiers can operate with power supply voltages from 2.5 V to 6.0 V. Each amplifier draws only 600 μ A quiescent current. The low supply voltage capability and low supply current are ideal for portable applications demanding high capacitive load driving capability and stable wide bandwidth. The TP156XAL1 family is optimized for wide bandwidth low power applications. They have an industry leading high GBWP to power ratio and are unity gain stable for any capacitive load. When the load capacitance increases, the increased capacitance at the output pushed the non-dominant pole to lower frequency in the open loop frequency response, lowering the phase and gain margin. Higher gain configurations tend to have better capacitive drive capability than lower gain configurations due to lower closed loop bandwidth and hence higher phase margin.

Ground Sensing and Rail to Rail Output

The TP156XAL1 family has excellent output drive capability, delivering over 100 mA of output drive current. The output stage is a rail-to-rail topology that is capable of swinging to within 10mV of either rail. Since the inputs can go 300 mV beyond either rail, the op-amp can easily perform ‘true ground’ sensing.

The maximum output current is a function of total supply voltage. As the supply voltage to the amplifier increases, the output current capability also increases. Attention must be paid to keep the junction temperature of the IC below 150°C when the output is in continuous short-circuit. The output of the amplifier has reverse-biased ESD diodes connected to each supply. The output should not be forced more than 0.5V beyond either supply, otherwise current will flow through these diodes.

Driving Large Capacitive Load

The TP156XAL1 family of OPA is designed to drive large capacitive loads. Refer to Typical Performance Characteristics for “Phase Margin vs. Load Capacitance”. As always, larger load capacitance decreases overall phase margin in a feedback system where internal frequency compensation is utilized. As the load capacitance increases, the feedback loop’s phase margin decreases, and the closed-loop bandwidth is reduced. This produces gain peaking in the frequency response, with overshoot and ringing in output step response. The unity-gain buffer ($G = +1V/V$) is the most sensitive to large capacitive loads.

When driving large capacitive loads with the TP156XAL1 OPA family (e.g., > 200 pF when $G = +1V/V$), a small series resistor at the output (RISO in Figure 3) improves the feedback loop’s phase margin and stability by making the output load resistive at higher frequencies.

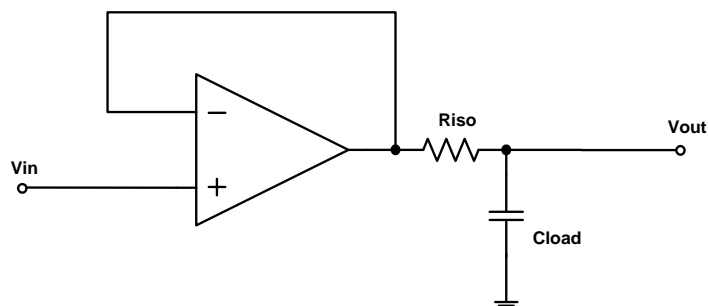

Tape and Reel Information

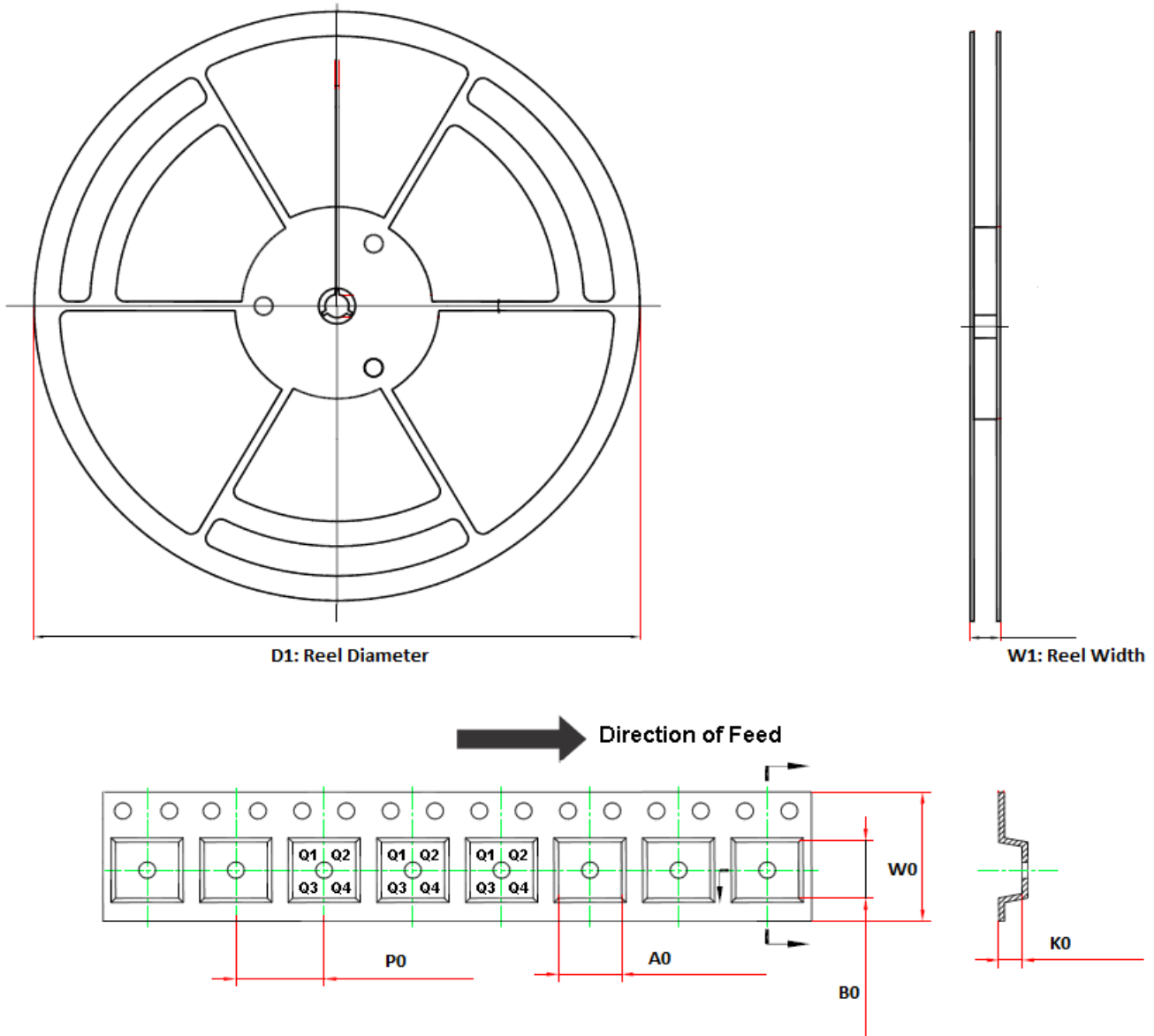

| Order Number | Package | D1 | W1 | A0 | B0 | K0 | P0 | W0 | Pin1 Quadrant |
|---------------|-----------------|-------|------|-----|------|-----|-----|------|------------------|
| TP1561AL1-CR | SOT353 (SC70-5) | 178.0 | 12.3 | 2.4 | 2.5 | 1.2 | 4.0 | 8.0 | Q3 |
| TP1561AUL1-CR | SOT353 (SC70-5) | 178.0 | 12.3 | 2.4 | 2.5 | 1.2 | 4.0 | 8.0 | Q3 |
| TP1561AL1-TR | SOT23-5 | 179.0 | 12.1 | 3.3 | 3.25 | 1.4 | 4.0 | 8.0 | Q3 |
| TP1562AL1-SR | SOP8 | 330.0 | 17.6 | 6.5 | 5.4 | 2.0 | 8.0 | 12.0 | Q1 |
| TP1562AL1-VR | MSOP8 | 330.0 | 17.6 | 5.2 | 3.3 | 1.5 | 8.0 | 12.0 | Q1 |
| TP1562AL1-TSR | TSSOP8 | 330.0 | 17.6 | 6.8 | 3.3 | 1.7 | 8.0 | 12.0 | Q1 |
| TP1562AL1-FR | DFN2X2-8 | 180.0 | 13.1 | 2.3 | 2.3 | 1.1 | 4.0 | 8.0 | Q1 |
| TP1564AL1-SR | SOP14 | 330.0 | 21.6 | 6.5 | 9.1 | 1.8 | 8.0 | 16.0 | Q1 |
| TP1564AL1-TR | TSSOP14 | 330.0 | 17.6 | 6.8 | 5.5 | 1.6 | 8.0 | 12.0 | Q1 |

Package Outline Dimensions

SOT353 (SC70-5)

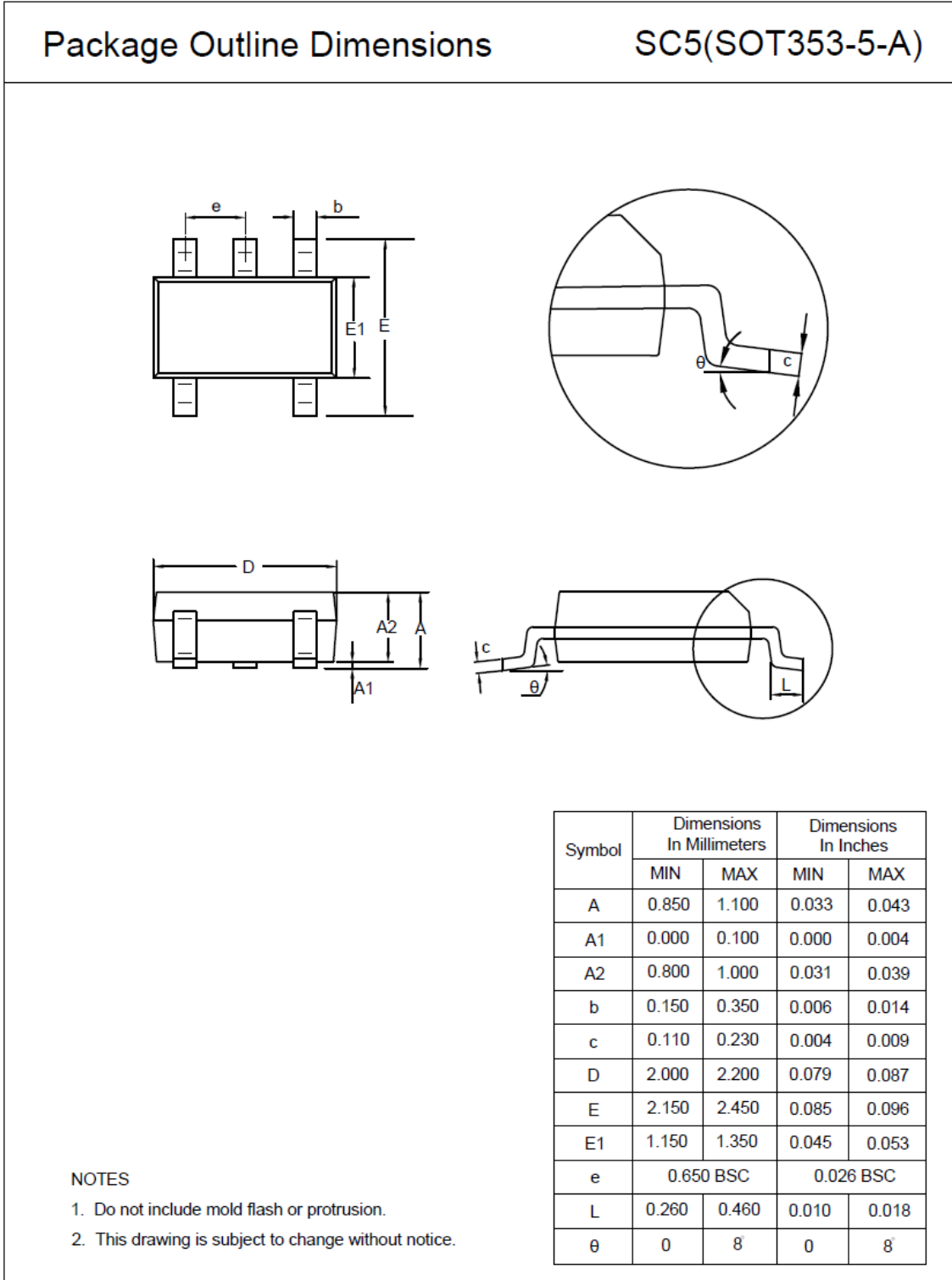

SOT23-5

Package Outline Dimensions

S5T(SOT23-5-A)

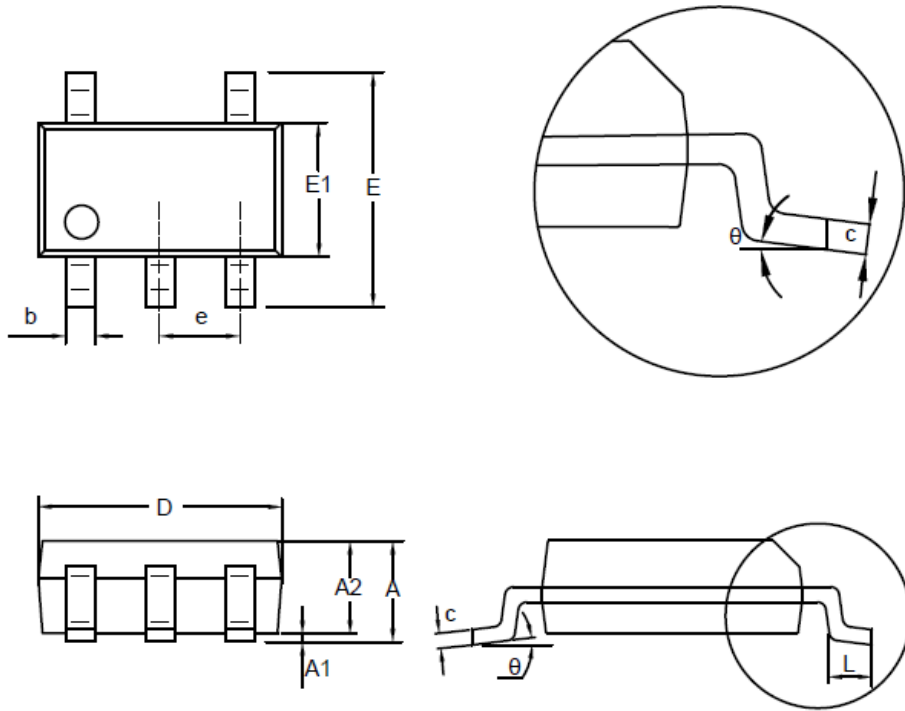

| Symbol | Dimensions In Millimeters | | Dimensions In Inches | |
|--------|---------------------------|-------|----------------------|-------|
| | MIN | MAX | MIN | MAX |
| A | 1.050 | 1.250 | 0.041 | 0.049 |
| A1 | 0.000 | 0.150 | 0.000 | 0.006 |
| A2 | 1.000 | 1.200 | 0.039 | 0.047 |
| b | 0.280 | 0.500 | 0.011 | 0.020 |
| c | 0.100 | 0.230 | 0.004 | 0.009 |
| D | 2.820 | 3.020 | 0.111 | 0.119 |
| E | 2.600 | 3.000 | 0.102 | 0.118 |
| E1 | 1.500 | 1.720 | 0.059 | 0.068 |
| e | 0.950 BSC | | 0.037 BSC | |
| L | 0.300 | 0.600 | 0.012 | 0.024 |
| θ | 0 | 8° | 0 | 8° |

NOTES

1. Do not include mold flash or protrusion.
2. This drawing is subject to change without notice.

SOP8

Package Outline Dimensions

SO1(SOP-8-A)

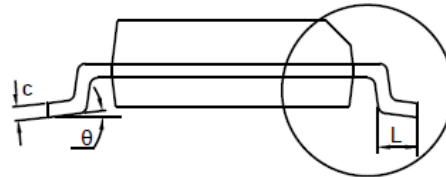
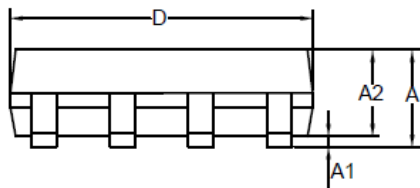
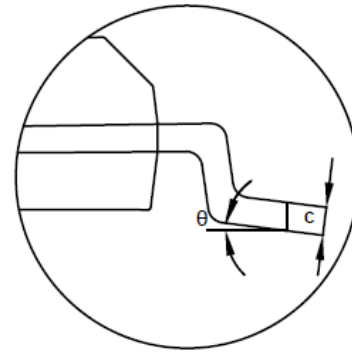
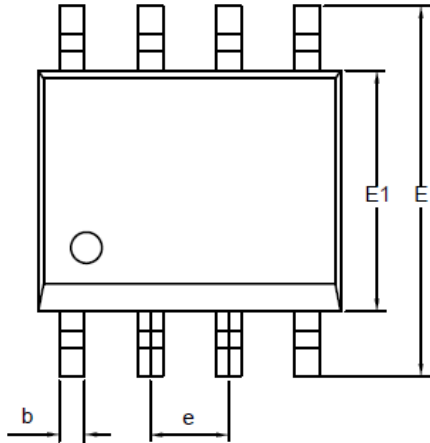

| Symbol | Dimensions In Millimeters | | Dimensions In Inches | |
|--------|---------------------------|-------|----------------------|-------|
| | MIN | MAX | MIN | MAX |
| A | 1.350 | 1.750 | 0.053 | 0.069 |
| A1 | 0.050 | 0.250 | 0.002 | 0.010 |
| A2 | 1.250 | 1.550 | 0.049 | 0.061 |
| b | 0.330 | 0.510 | 0.013 | 0.020 |
| c | 0.170 | 0.250 | 0.007 | 0.010 |
| D | 4.700 | 5.100 | 0.185 | 0.201 |
| E | 5.800 | 6.200 | 0.228 | 0.244 |
| E1 | 3.800 | 4.000 | 0.150 | 0.157 |
| e | 1.270 BSC | | 0.050 BSC | |
| L | 0.400 | 1.000 | 0.016 | 0.039 |
| θ | 0 | 8° | 0 | 8° |

NOTES

1. Do not include mold flash or protrusion.
2. This drawing is subject to change without notice.

TSSOP8

Package Outline Dimensions

TS1(TSSOP-8-A)

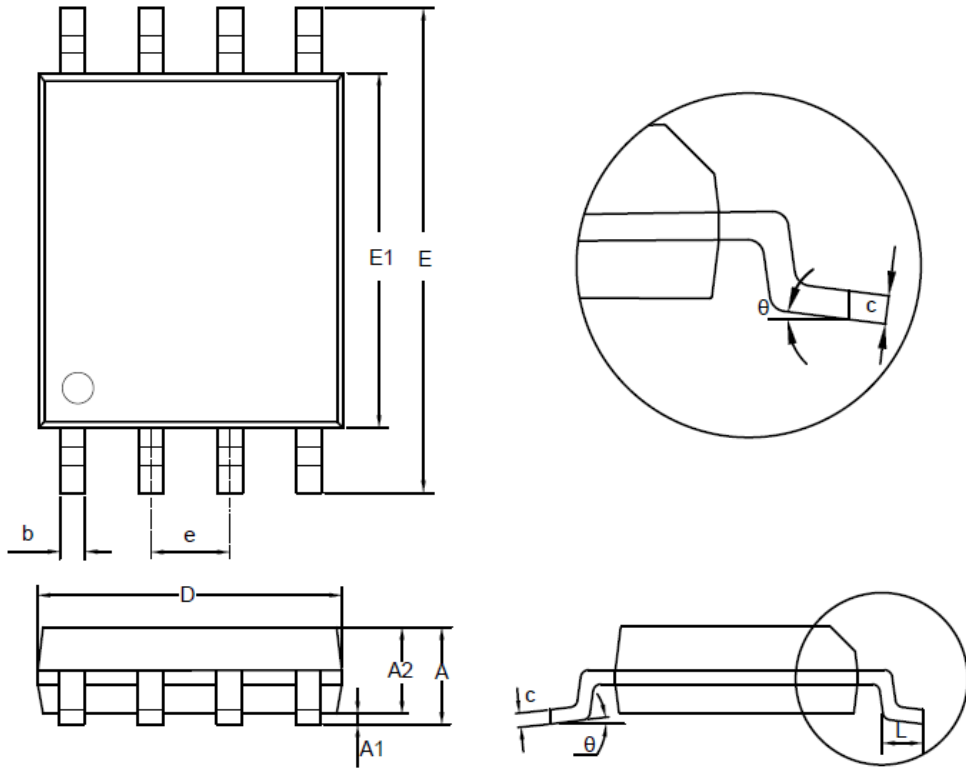

| Symbol | Dimensions In Millimeters | | Dimensions In Inches | |
|--------|------------------------------|-------|-------------------------|-------|
| | MIN | MAX | MIN | MAX |
| A | 0.900 | 1.200 | 0.035 | 0.047 |
| A1 | 0.050 | 0.150 | 0.002 | 0.006 |
| A2 | 0.800 | 1.050 | 0.031 | 0.041 |
| b | 0.190 | 0.300 | 0.007 | 0.012 |
| c | 0.090 | 0.200 | 0.004 | 0.008 |
| D | 2.900 | 3.100 | 0.114 | 0.122 |
| E | 6.200 | 6.600 | 0.244 | 0.260 |
| E1 | 4.300 | 4.500 | 0.169 | 0.177 |
| e | 0.650 BSC | | 0.026 BSC | |
| L | 0.450 | 0.750 | 0.018 | 0.030 |
| θ | 0 | 8° | 0 | 8° |

NOTES

1. Do not include mold flash or protrusion.
2. This drawing is subject to change without notice.

MSOP8

Package Outline Dimensions

VS1(MSOP-8-A)

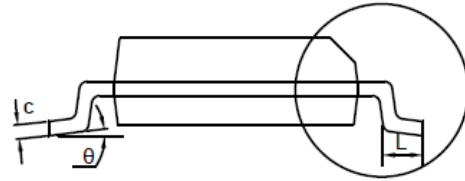
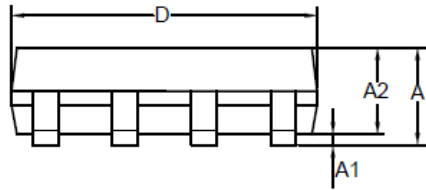
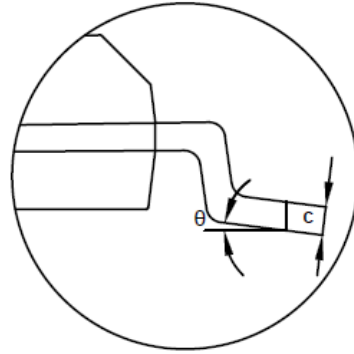
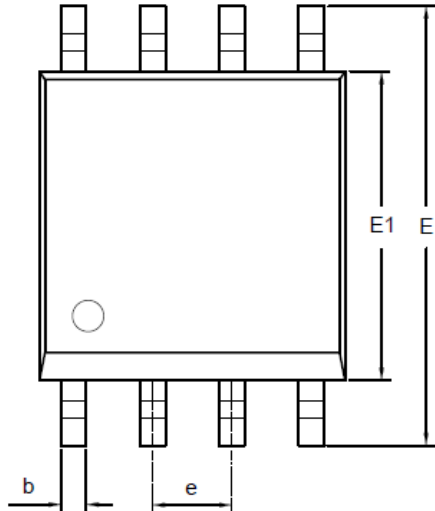

| Symbol | Dimensions In Millimeters | | Dimensions In Inches | |
|--------|---------------------------|-------|----------------------|-------|
| | MIN | MAX | MIN | MAX |
| A | 0.800 | 1.100 | 0.031 | 0.043 |
| A1 | 0.050 | 0.150 | 0.002 | 0.006 |
| A2 | 0.750 | 0.950 | 0.030 | 0.037 |
| b | 0.250 | 0.380 | 0.010 | 0.015 |
| c | 0.090 | 0.230 | 0.004 | 0.009 |
| D | 2.900 | 3.100 | 0.114 | 0.122 |
| E | 4.700 | 5.100 | 0.185 | 0.201 |
| E1 | 2.900 | 3.100 | 0.114 | 0.122 |
| e | 0.650 BSC | | 0.026 BSC | |
| L | 0.400 | 0.800 | 0.016 | 0.031 |
| θ | 0 | 8° | 0 | 8° |

NOTES

1. Do not include mold flash or protrusion.
2. This drawing is subject to change without notice.

DFN2X2-8

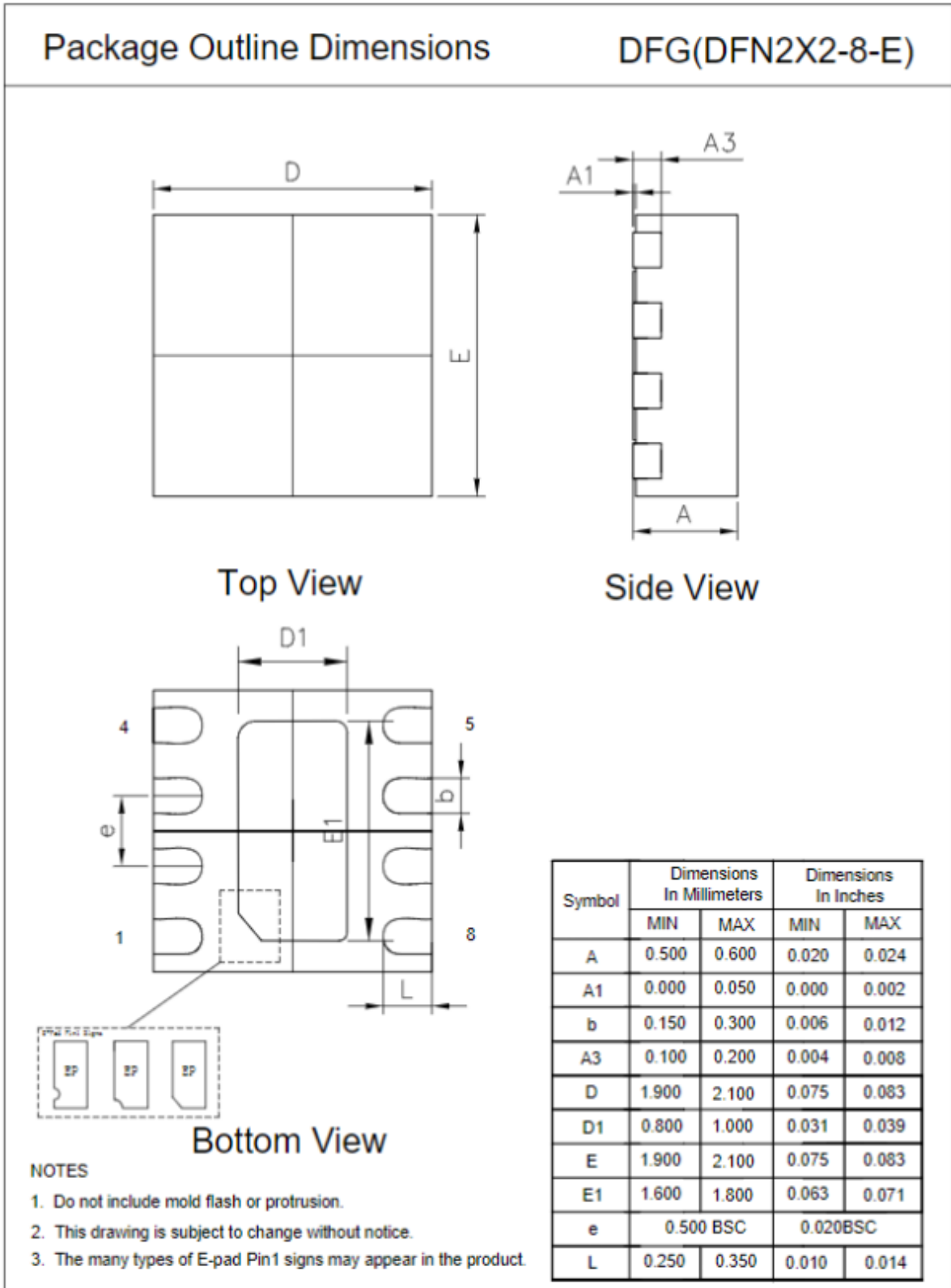

SOP14

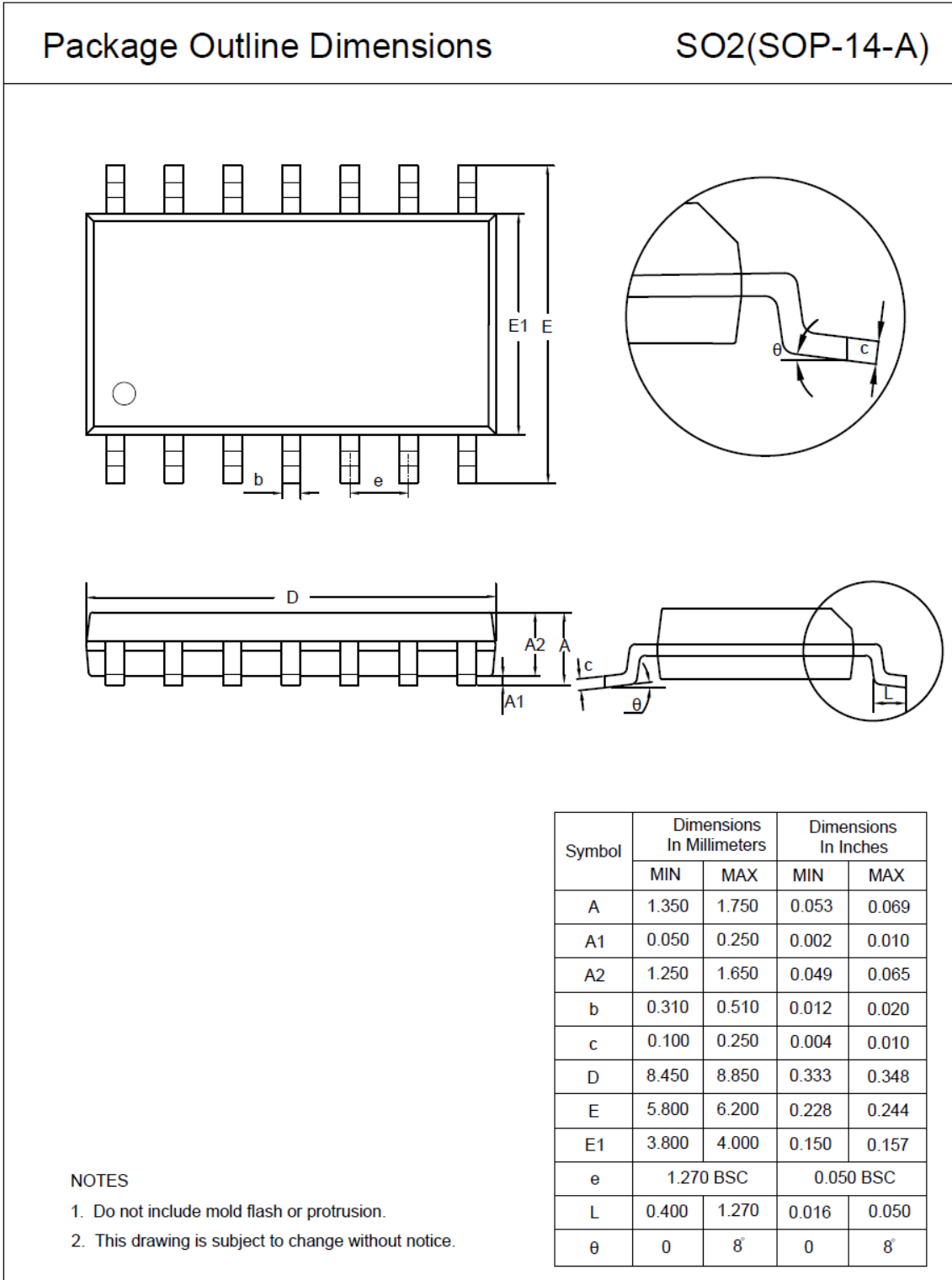

TSSOP14

Package Outline Dimensions

TS2(TSSOP-14-A)

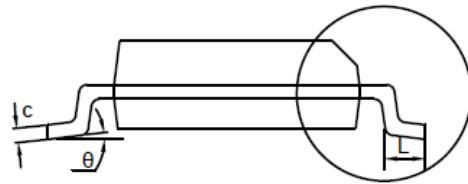
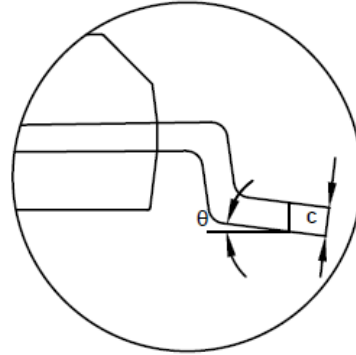
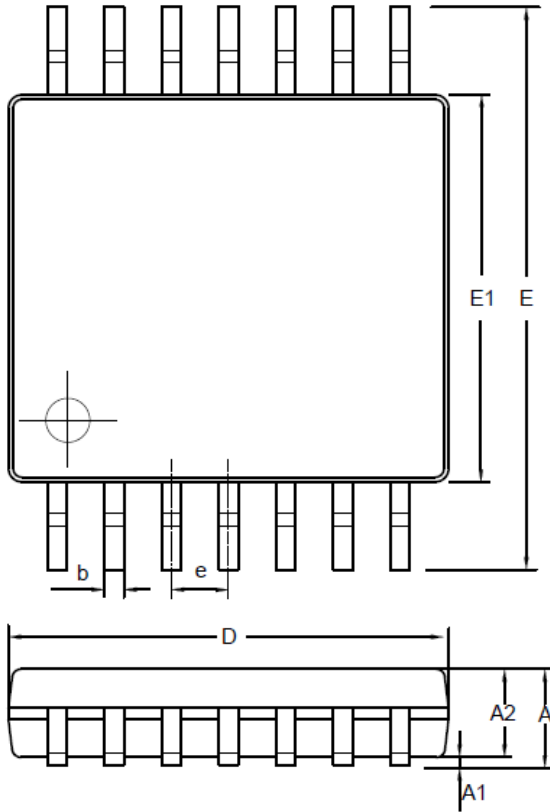

| Symbol | Dimensions In Millimeters | | Dimensions In Inches | |
|--------|---------------------------|-------|----------------------|-------|
| | MIN | MAX | MIN | MAX |
| A | 0.900 | 1.200 | 0.035 | 0.047 |
| A1 | 0.050 | 0.150 | 0.002 | 0.006 |
| A2 | 0.800 | 1.050 | 0.031 | 0.041 |
| b | 0.190 | 0.300 | 0.007 | 0.012 |
| c | 0.090 | 0.200 | 0.004 | 0.008 |
| D | 4.900 | 5.100 | 0.193 | 0.201 |
| E | 6.200 | 6.600 | 0.244 | 0.260 |
| E1 | 4.300 | 4.500 | 0.169 | 0.177 |
| e | 0.650 BSC | | 0.026 BSC | |
| L | 0.450 | 0.750 | 0.018 | 0.030 |
| θ | 0 | 8° | 0 | 8° |

NOTES

1. Do not include mold flash or protrusion.
2. This drawing is subject to change without notice.

IMPORTANT NOTICE AND DISCLAIMER

Copyright© 3PEAK 2012-2023. All rights reserved.

Trademarks. Any of the 思瑞浦 or 3PEAK trade names, trademarks, graphic marks, and domain names contained in this document /material are the property of 3PEAK. You may NOT reproduce, modify, publish, transmit or distribute any Trademark without the prior written consent of 3PEAK.

Performance Information. Performance tests or performance range contained in this document/material are either results of design simulation or actual tests conducted under designated testing environment. Any variation in testing environment or simulation environment, including but not limited to testing method, testing process or testing temperature, may affect actual performance of the product.

Disclaimer. 3PEAK provides technical and reliability data (including data sheets), design resources (including reference designs), application or other design recommendations, networking tools, security information and other resources "As Is". 3PEAK makes no warranty as to the absence of defects, and makes no warranties of any kind, express or implied, including without limitation, implied warranties as to merchantability, fitness for a particular purpose or non-infringement of any third-party's intellectual property rights. Unless otherwise specified in writing, products supplied by 3PEAK are not designed to be used in any life-threatening scenarios, including critical medical applications, automotive safety-critical systems, aviation, aerospace, or any situations where failure could result in bodily harm, loss of life, or significant property damage. 3PEAK disclaims all liability for any such unauthorized use.